

Polias e tensores de correias

2008

Catálogo ilustrado de aplicações e equivalências para linhas de automóveis, utilitários, caminhões e ônibus

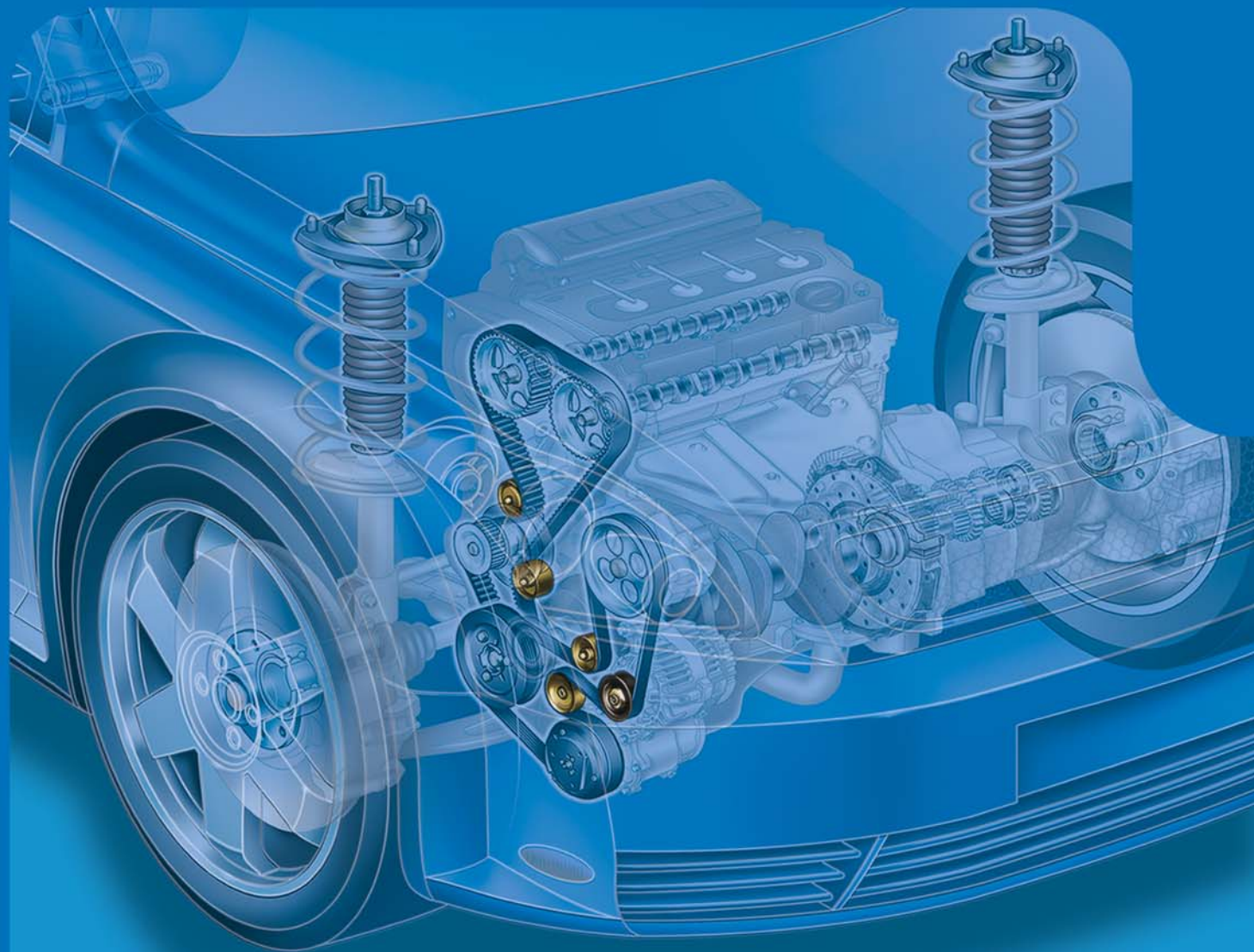

Índice geral de produtos

Equivalência

Produto	Montadora	Pág	INA	Nytron
VKM 4592	Fiat	10		1167
VKM 4594	Fiat	11		7822
VKM 4597	Renault	25		1256
VKM 4599	Renault	25		1182
VKM 4611	Renault	25		1153
VKM 4614	Fiat	11		7785
VKM 4617	Peugeot Renault	23 25	F-236389	7769
VKM 4752	GM	15		7814
VKM 4753	Fiat GM	11 15		7795
VKM 4754	Fiat	11		7709
VKM 4756	Ford	12		7776
VKM 4758	Ford	12		1116
VKM 4759	Citroen Peugeot	8 23		7726
VKM 4760	VW	29	F-229021.1	7729CS
VKM 4761	VW	30	F-231221.1	7749
VKM 4762	VW	30		7753
VKM 4763	MBB	19		1224
VKM 4764	Scania	26		1242
VKM 4765	Scania	26		1243
VKM 4766	MBB	19		1253
VKM 4767	Ford	12		1261
VKM 4768	Volvo	28		7715
VKM 4769	Ford VW	12 30		7718
VKM 4770	Ford VW	12 30		7719
VKM 4771	Ford	12		7728
VKM 4772	Ford	12		7773
VKM 4773	Renault	25	F-123154.3	1148
VKM 4774	VW	30		7798
VKM 4775	GM	15		7808
VKM 4776	Ford Troller	13 27	F-565352	7811
VKM 4777	GM	15		7812
VKM 4778	Ford	13		7818
VKM 4779	GM	15		7820
VKM 4780	VW	30	F-565360	7831
VKM 4781	Ford GM MBB	13 15 19		7832
VKM 4782	Scania	26		7833
VKM 4783	MBB	19		7834
VKM 4784	MBB	19		7835
VKM 4786	Ford	13		7775
VKM 4787	Iveco - Fiat	18		1234
VKM 4788	Ford GM MBB	13 16 19	F-140070.1 / F-140564.1	7739
VKM 4789	Citroen Peugeot	8 23		1250
VKM 4790	Audi VW	6 30		1125
VKM 4791	Citroen Peugeot	9 23		1162
VKM 4792	Renault	25	F-121366	1235
VKM 4793	Ford GM	13 16		1225
VKM 4794	GM	16		1139
VKM 4795	MBB	19		
VKM 4796	MBB	19		
VKM 4797	Honda	17		7756
VKM 4798	MBB	19		
VKM 4799	Ford	13		7721
VKM 4800	Citroen Peugeot	9 23	F-121287.5	7762
VKM 4801	Renault	25		1147
VKM 4802	Renault	26	F-124059	1151

Equivalência

Produto	Montadora	Pág	INA	Nytron
VKM 4803	Renault	26		7765
VKM 4804	Toyota	27		2060
VKM 4805	Toyota	27		7779
VKM 4806	Fiat VW	11 30	F-565353 F-565353	1143 1140
VKM 4807	Peugeot Renault	23 26		1150
VKM 4808	Renault	26		1154
VKM 4810	Fiat GM MBB	11 16 19		1178
VKM 4812	Fiat	11		1239
VKM 4813	Fiat GM	11 16		7858
VKM 4817	Audi VW	6 30		7806
VKM 4818	MBB	20		7865
VKM 4819	Renault	26		1230
VKM 4822	Fiat	11		1133
VKM 4823	Ford VW	13 30		1112
VKM 4824	Ford VW	13 30		1113
VKM 4834	Agrale Ford GM Nissan Troller Agrale	5 13 16 20 28 5		1128
VKM 4835	Ford GM Nissan Troller	13 16 21 28		1222
VKM 4836	Agrale Ford GM	5 13 16		1226
VKM 4837	Audi VW	7 30		1114
VKM 4838	VW	31		1152
VKM 4839	Ford Seat VW	14 27 31	F-235786.01	1160
VKM 4840	Ford	14		7720
VKM 4841	Fiat	11		7734
VKM 4842	Ford	14		7826
VKM 4845	GM	16		
VKM 11000 H	Ford Seat VW	12 26 28	F-217668.05 / F-217668.2C	7782
VKM 11008	Audi VW	5 28		
VKM 11020	Audi VW	5 28		
VKM 11021	VW	28		
VKM 11106 L	VW	28	F-232489	7737
VKM 11107 L	Audi VW	5 28		7736
VKM 11113	Audi Seat VW	6 26 28	F-123814	
VKM 11115	Audi VW	6 28		7713
VKM 11116	VW	29		
VKM 11201	Audi	6		
VKM 11202	Audi VW	6 29		
VKM 12005	Fiat	9		7747
VKM 12101	Fiat	9		7746
VKM 12172	Fiat	9		7733
VKM 12173	Alfa Romeo	5		

Índice geral de produtos

Equivalência				
Produto	Montadora	Pág	INA	Nytron
VKM 12200 H	Fiat	9	F-113181	7732
VKM 12201 L	Fiat	9	F-236854	7742
VKM 12227	Fiat	9	F-123638	7744
VKM 12242 L	Fiat	9	F-233127.1	7735
VKM 12299	Fiat	9	F-110806.2	7741
VKM 13100	Citroen	7	F-121287.5	7772/7762
	Peugeot	21		
VKM 13132	Citroen	7	F-232829.5	7770
	Peugeot	21		
VKM 13202	Citroen	7		7763
	Peugeot	21		
VKM 13210	Citroen	7		7760
	Peugeot	21		
VKM 13211	Citroen	7		7761
	Peugeot	21		
VKM 13214	Citroen	7		7778
	Peugeot	21		
VKM 13218	Citroen	7		
VKM 13234	Citroen	7		
	Peugeot	21		
VKM 13256	Citroen	7		
	Peugeot	21		
VKM 13902	Peugeot	21		
	Renault	23		
VKM 14210	Ford	12	F-140221	1258
VKM 15121 L	GM	14	F-232482	7792
VKM 15202 L	GM	14	F-232488	7797
VKM 15211	GM	14		
VKM 15216 L	Fiat	9	F-232481	7723 CP
	GM	14		
VKM 15402 L	Fiat	9	F-234394	7796
	GM	14		
VKM 16000	Renault	23	F-123958	1149
VKM 16020 L	Renault	23	F-550228	7759
VKM 16101 H	Renault	24		1256
VKM 16112 H	Renault	24	F-120180	
VKM 16200	Renault	24		
VKM 16204	Renault	24		
VKM 16212	Renault	24		
VKM 16550 A	Renault	24		7768
VKM 16602	Renault	24		
VKM 21004	Audi	6		7729
	VW	29		
VKM 21115	Audi	6		7711
	VW	29		
VKM 21120 H	VW	29	F-23121901	2053
VKM 21122 H	VW	29	F-227244	2092
VKM 21201	Audi	6		
VKM 21202	Audi	6		
	VW	29		
VKM 22174	Fiat	10		1136
VKM 22177	Alfa Romeo	5	F-231098	1232
	Fiat	10		
VKM 22242 A	Fiat	10	F-110628.3	2054
VKM 22380	Citroen	8		7751
	Iveco - Fiat	18		
	Peugeot	22		
	Renault	24		
VKM 22385	Citroen	8	F-113338	7752
	Iveco - Fiat	18		
	Peugeot	22		
	Renault	24		
VKM 23130	Citroen	8	F-122574.5	1251
	Peugeot	22		
VKM 23213 H	Citroen	8		
	Peugeot	22		
VKM 23214	Citroen	8		7764
	Peugeot	22		

Equivalência				
Produto	Montadora	Pág	INA	Nytron
VKM 23230	Citroen	8		1280
	Peugeot	22		
VKM 23256	Citroen	8		
	Peugeot	22		
VKM 23900	Peugeot	22		
	Renault	24		
VKM 23901	Peugeot	22		
	Renault	24		
VKM 24210 H	Ford	12	F-140222	1260
VKM 24211 H	Ford	12	F-140223	1259
VKM 25150 H	Fiat	10	F-224967	2040
	GM	14		
VKM 25152 H	Fiat	10	F-224971	2039
	GM	14		
VKM 25211	GM	14		
VKM 25212 H	GM	15	F-224964	2041
VKM 25213 H	GM	15	F-224966	2038
VKM 25224	GM	15	F-231413	2042
VKM 26101 H	Renault	24		7767
VKM 26102 H	Renault	25		
VKM 26602	Renault	25		
VKM 31004	VW	29	F-214797.6	1173
	Audi	6		
VKM 31011 L	Seat	26	F-235782	
	VW	29		
VKM 31015 L	Seat	26	F-235786.01	7799
	VW	29		
VKM 32001	Fiat	10		1248
VKM 32002	Fiat	10		1137
VKM 32005 H	Fiat	10	F-110672-300	1144
VKM 32009	Fiat	10		1142
VKM 32010	Alfa Romeo	5		1238
VKM 32015	Fiat	10	F-123800	1233
VKM 32022	Alfa Romeo	5		1245
	Fiat	10		
VKM 33003	Citroen	8		
	Peugeot	22		
VKM 33012	Peugeot	22		
VKM 33023	Peugeot	22		1239
VKM 33037	Peugeot	23		1244
VKM 33042	Citroen	8		7710
VKM 33074	Citroen	8		
	Peugeot	23		
VKM 33101	Peugeot	23		1123
VKM 34010	Ford	12		7867
VKM 35002 L	GM	15	F-110811-2	1223
VKM 35008 L	GM	15		7817
VKM 35009 L	GM	15	F-235783 / F-235784	7815 / 7816
VKM 36005	Renault	25		
VKM 36010	Renault	25		7780
VKM 36013	Renault	25	F-120850	1145
VKM 38004	BMW	7		1117
VKM 38016	BMW	7		
	Agrale	5		
	Fiat	11		
VKM 60001 A	Ford	14		1129
	GM	16		
	Nissan	21		
	Troller	28		
VKM 60003 L	VW	31	F-551221	7743
VKM 60004 A	GM	16	F-44818	7783
VKM 60005 A	GM	16	F-44818.2	7784
VKM 60006 A	Fiat	11		7786CS
VKM 60007 A	GM	17	F-550461	7790
VKM 60008 L	VW	31		7801
VKM 60009 L	VW	31		7802
VKM 60012 A	GM	17		1166

Polias e tensores de correias





Equivalência

Produto	Montadora	Pág	INA	Nyton
VKM 60013 A	Agrale	5		
	GM	17		7819
	Nissan	21		
	Troller	28		
VKM 60014 A	GM	17		1171
VKM 71002	Toyota	27		
VKM 71007	Toyota	27		7722
VKM 73000	Honda	17		
VKM 73005	Honda	17		
VKM 73011	Honda	17		
VKM 73201	Honda	17		
VKM 73600	Honda	17		
VKM 74002	Mazda	18		
VKM 74004	Kia	18		1158
VKM 74600	Kia	18		
	Mazda	18		
VKM 75000	Mitsubishi	20		2058
VKM 75004	Hyundai	17		7777
	Mitsubishi	20		
VKM 75009	Mitsubishi	20		2050
VKM 75044	Hyundai	17		2055
	Mitsubishi	20		
VKM 75064	Mitsubishi	20		2051
VKM 75144	Hyundai	18		2049
VKM 75601	Hyundai	18	F-124070	7789
	Mitsubishi	20		
VKM 75612	Hyundai	18	F-124052	7757
	Mitsubishi	20		
VKM 75613	Mitsubishi	20		
VKM 76001	Suzuki	27		
VKM 76202	Suzuki	27		
VKM 77300	Asia	5		1159
VKM 78000	Subaru	27		
VKM 81002	Toyota	27		
VKM 84000	Mazda	19		
VKM 84601	Kia	18		
	Mazda	19		
VKM 85000	Hyundai	18		2052
	Mitsubishi	20		
VKM 85002	Mitsubishi	20		2059
VKM 88000	Subaru	27		
VKM 88001	Subaru	27		

Polias e tensores de correias





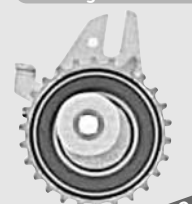

Principais aplicações

AGRALE

Produtos equiv.	NYTRON	INA
VKM 4834	1128	
Nº original 940703800024		
	Volare com ar cond. 00...	
VKM 4835	1222	
Nº original 940703810094		
	Volare sem ar cond. 00...	
VKM 4836	1226	
Nº original 940703800014		
	Volare com ar cond. ...00	
VKM 60001 A	1129	
Nº original 940703410074		
	Volare (motor MWM)	
VKM 60013 A	7819	
Nº original 940703410074		
	Volare	
	Tensor da correia do alternador	
VKM 12173		
Nº original 60602136		
	145 1.8 16V 12/96...01/01 e 2.0 16V 10/95...01/01; 147 2.0 16V 01/01...03/04; 155 2.0 16V 01/96...12/97	
	Tensor da correia sincronizadora	

ALFA ROMEO

ALFA ROMEO - Continuação

Produtos equiv.	NYTRON	INA
VKM 22177	1232	F-231098
Nº original 60671573		
	145 1.8 16V 12/96...01/01 e 2.0 16V 10/95...01/01 motor AR 32301 e 67299; 147 2.0 16V 01/01...03/04; 155 2.0 16V 96...97	
	Polia da correia sincronizadora	
VKM 32010	1238	
Nº original 60561614		
	164 09/92...09/98 (3.0 24V)	
	Tensor da correia de serviço	
VKM 32022	1245	
Nº original 46524692		
	145 12/96...12/97 (1.8 16V com AC) e 12/96...01/01 (1.8 16V sem AC)	
	Tensor da correia de serviço	
VKM 77300	1159	
Nº original AA10012700A		
	Townner	
	Tensor da correia sincronizadora	
VKM 11008		
Nº original 058 109243 C/E		
	A4, A4 Avant, A4 Avant Quattro, A4 Quattro 1.8 (todos correia com 153 dentes)	
	Tensor da correia sincronizadora	
VKM 11020		
Nº original 051 109243		
	A6, A6 Avant, A6 Avant Quattro, A6 Quattro (todos 1.8 e 1.8T)	
	Tensor da correia sincronizadora	







ASIA

AUDI





Polias e tensores de correias

Principais aplicações

AUDI - Continuação

Produtos equiv.	NYTRON	INA
VKM 11107 L	7736	
Nº original 030 109243 L/M		
	A3 1.6 8V motor EA111	
Tensor da correia sincronizadora		
VKM 11113		F-123814
Nº original 06A 109479 A/C		
	A3 Nac. e Imp. (1.6 05/99...07/02)	
Tensor da correia sincronizadora		
VKM 11115	7713	
Nº original 06B 109243		
	A3 (1.8/1.8T 20V Nac. e Imp. 09/96...), A4 (1.8T 01/95...11/00), TT (1.8T 10/98...)	
Tensor da correia sincronizadora		
VKM 11201		
Nº original 078 109243 K		
	80 2.6 e 2.8 V6 (94...01/96); A4 2.8 V6 (01/95...07/97); A6 2.8 12V (96...97)	
Tensor (sem regulador) da correia sincronizadora		
VKM 11202		
Nº original 078 109243 Q/R		
	A4 e A4 Avant (2.4 30V 03/97...09/01 e 2.8 V6)	
Tensor (com regulador) da correia sincronizadora		
VKM 21004	7729	
Nº original 058 109244		
	A4, A4 Avant, A4 Avant Quattro, A4 Quattro 1.8 (todos correia com 153 dentes)	
Polia (sem suporte) da correia sincronizadora		

AUDI - Continuação

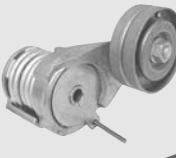
Produtos equiv.	NYTRON	INA
VKM 21115	7711	
Nº original 06B 109477		
	A3 (1.8/1.8T 20V Nac. e Imp. 09/96...), A4 (1.8T 01/95...11/00), TT (1.8T 10/98...)	
Tensor hidráulico da correia sincronizadora		
VKM 21201		
Nº original 078 109244 G		
	80 2.6 e 2.8 V6 (94...01/96); A4 2.8 V6 (01/95...07/97); A6 2.8 12V (96...97)	
Polia (com regulador) da correia sincronizadora		
VKM 21202		
Nº original 078 109244 H		
	A4 e A4 Avant (2.4 30V 03/97...09/01 e 2.8 V6)	
Polia (com regulador) da correia sincronizadora		
VKM 31011 L		F-235782
Nº original 06A 903 315 E		
	A3 96...08/00 1.6; 1.8; 1.8T	
Tensor do alternador		
VKM 4790	1125	
Nº original 032 145276		
	A3 07/02... (1.6 com AC)	
Polia do alternador		
VKM 4817	7806	
Nº original 032 145 299 A / 030 145 299 F		
	A3 09/00... (1.6 com AC e com DH)	
Tensor (com suporte) do alternador		

Polias e tensores de correias

Principais aplicações

AUDI - Continuação

Produtos equiv.	NYTRON	INA
VKM 4837	1114	
Nº original 032 145299 A / 036 145276		
A3 09/00... (1.6 com AC e com DH)		



NOVO Polia (sem suporte) do alternador

BMW

Produtos equiv.	NYTRON	INA
VKM 38004	1117	
Nº original 11281748131		
316 07/93...08/00 e 318 (todos com alternador 80 A)		



Polia do alternador

Produtos equiv.	NYTRON	INA
VKM 38016		
Nº original 316 07/93...08/00 e 318 (todos com alternador 80 A)		



NOVO Polia do alternador

CITROEN

Produtos equiv.	NYTRON	INA
VKM 13100	7772 / 7762	F-121287.5
Nº original 97535002 / 0829.19		
Berlino 05/97... (1.8 8V XU7JB), Xantia 03/93... (2.0 8V XU10J2C), Xsara 04/97...07/00 (1.8 8V XU7JB e XU7JP), ZX 07/92...07/97 (1.8 8V XU7JP correia 114 dentes e 2.0 8V XU10J2C)		



Tensor da correia sincronizadora

Produtos equiv.	NYTRON	INA
VKM 13132	7770	F-232829.5
Nº Original: 0829.82 / 0829.C7		
Berlino e Xsara (10/00...) e C3 (02/02...) todos motor 1.6 16V TU5JP4 até motor 1806404		



NOVO Tensor da correia sincronizadora (73 mm)

Produtos equiv.	NYTRON	INA
VKM 13202	7763	
Nº original 0829.32 / 0829.35		
Evasion (05/98...04/00), Xantia (06/95...) e Xsara (04/97...03/00) (todos 2.0 16V XU10J4R/RS)		



NOVO Tensor da correia sincronizadora

CITROEN - Continuação

Produtos equiv.	NYTRON	INA
VKM 13210	7760	
Nº original 0829.20 / 91538722		
Xantia (03/93...01/98), ZX (07/92...06/97) (2.0 16V XU10J4/Z)		



NOVO Tensor da correia sincronizadora

Produtos equiv.	NYTRON	INA
VKM 13211	7761	
Nº original 0829.46 / 96137001		
Xantia (03/93...01/98), ZX (07/92...06/97) (2.0 16V XU10J4/Z)		



NOVO Tensor da correia sincronizadora

Produtos equiv.	NYTRON	INA
VKM 13214	7778	
Nº original 0829.69 / 9635336880		
Xantia (06/95...), Xsara (04/97...09/00) (1.8 16V XU7JP4)		



NOVO Tensor da correia sincronizadora

Produtos equiv.	NYTRON	INA
VKM 13218		
Nº original 0829.84		
Xsara 04/00... (2.0 16V XU10J4RS)		



NOVO Tensor da correia sincronizadora

Produtos equiv.	NYTRON	INA
VKM 13234	7771	
Nº original 9643329680 / 0829.96		
C4 (11/04...), C5 (03/01...), Evasion (05/00...07/02); Xsara (09/00...), Xsara Picasso (01/03...) (2.0 16V EW10J4/J4S)		



NOVO Tensor da correia sincronizadora

Produtos equiv.	NYTRON	INA
VKM 13256		
Nº Original: 0829.A0 / 0829.C8		
Berlino e Xsara (10/00...), C3 (02/02...) e C4 (11/04...) todos motor 1.6 16V TU5JP4 a partir motor 1806405		











NOVO Tensor da correia sincronizadora (70 mm)













Polias e tensores de correias

Principais aplicações

CITROEN - Continuação

Produtos equiv.	NYTRON	INA
VKM 22380	7751	
Nº original 0830.32		
	Jumper 2.8 HDi (07/00... 01 peça)	
Polia da correia sincronizadora		
VKM 22385	7752	F-113338
Nº original 0830.40 / 99432547		
	Jumper 2.8 D/TD (02/94...04/02 02 peças) e HDi (07/00... 01 peça)	
Polia da correia sincronizadora		
VKM 23130	1251	F-122574.5
Nº Original 0830.20 / 0830.61		
	Berlingo e Xsara (10/00...) e C3 (02/02...) todos motor 1.6 16V TU5JP4 até motor 1806404	
	Polia da correia sincronizadora (57 mm)	
VKM 23213 H		
Nº original 96099089 / 96201309		
	Evasion (05/98...04/00), Xantia (06/95...), Xsara (04/97...03/00) (todos 2.0 16V XU10J4R/RS)	
	Polia da correia sincronizadora	
VKM 23214	7764	
Nº original 96099089/96201309/0830.11/0830.14/0830.37		
	Xantia 06/95... e Xsara 04/97...09/00 (1.8 16V XU7JP4) e Xsara 04/00... (2.0 16V XU10J4RS)	
	Polia da correia sincronizadora	
VKM 23230	1280	
Nº original 0830.42		
	C4 (09/04...), C5 (03/01...), Evasion 05/00...07/02; Xsara (09/00...), Xsara Picasso (01/03...) (2.0 16V EW10J4/J4S e EW10A)	
Polia da correia sincronizadora		

CITROEN - Continuação

Produtos equiv.	NYTRON	INA
VKM 23256		
Nº Original: 0829.A1 / 0830.62		
	Berlingo e Xsara (10/00...), C3 (02/02...) e C4 (11/04...) todos motor 1.6 16V TU5JP4 a partir motor 1806405	
	Polia da correia sincronizadora (60 mm)	
VKM 33003		
Nº original 5751.18		
	Berlingo 1.8, Xantia e Xsara (1.8 16V e 2.0 16V) (todos sem AC motores XU7JB, XU7JP4, XU7JP, XU10J2C, XU10J4, EW10JP4)	
	Tensor da correia de serviço	
VKM 33042	7710	
Nº Original 5751.91		
	C3 02/02...11/03 (com AC motor 1.4 8V TU3JP e 1.6 16V TU5JP4)	
	Polia da correia de serviço	
VKM 33074		
Nº Original 5751.C3		
	C3 12/03... (OPS 09884...com AC motor 1.4 8V TU3JP/ETEJ4 e 1.6 16V TU5JP4/ETEJ4)	
	Tensor da correia de serviço	
VKM 4759	7726	
Nº original 0829.90		
	C3 02/02... (mot 3666766... TU3JP 1.4 8V - correia de 104 dentes)	
	Tensor da correia sincronizadora	
VKM 4789	1250	
Nº original 5751.98		
	Xsara 1.6 16V 01...	
	Polia da correia do alternador	

Polias e tensores de correias

Principais aplicações

CITROEN - Continuação

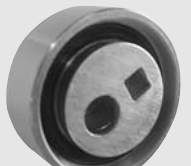
Produtos equiv.	NYTRON	INA
VKM 4791	1262	
Nº original 5751.50		
	Berlino e Xsara (sem AC 1.6 16V TU5JP4)	
NOVO	Tensor da correia de serviço	
VKM 4800	7762	F-121287.5
Nº original 97535002/0829.19/0829.29		
	Berlino 1.8 8V (05/97...), Xantia 2.0 8V (03/93...), Xsara 1.8 8V (04/97...07/00), ZX 1.8 8V correia 114 dentes e 2.0 8V (07/92...07/97)	
NOVO	Tensor da correia sincronizadora	

FIAT

VKM 12005	7747	
Nº original 5956109		
	Tempra 2.0 8V	
	Tensor da correia sincronizadora (Diâmetro externo 59,5mm)	
VKM 12101	7746	
Nº original 5997325		
	Uno 1.5/1.6R (87...89), Prêmio/Elba CS/CSL (86...89), Tipo 2.0 16V e Tempra 16V	
	Tensor da correia sincronizadora	

VKM 12172	7733	
Nº original 7772961		
	Marea 2.0 20V, Marea 2.0 20V Turbo, Marea 2.4 20V e Stilo 2.4 20V	
	Tensor da correia sincronizadora	

VKM 12200 H	7732	F-113181
Nº original 5972277 / 71740977		
	Palio, Palio Weekend, Siena 1.0 (96...); Siena 1.5 (96...98); Siena 1.6 (98...); Uno, Premio, Elba, Fiorino (92...); Strada 1.5 8V; Tipo 1.6 8V (93...97)	
	Tensor da correia sincronizadora	

FIAT - Continuação

Produtos equiv.	NYTRON	INA
VKM 12201 L	7742	F-236854
Nº original 46403679 / 46817666		
	Palio, Palio Weekend, Siena e Doblò (todos motor Fire 1.0 16V e 1.3 16V)	
	Tensor da correia sincronizadora	
VKM 12227	7744	F-123638
Nº original 7541718		
	Tempra SW e Tipo 2.0 8V	
	Tensor da correia sincronizadora (diâmetro externo 60,2 mm)	

VKM 12242 L	7735	F-233127.1
Nº original 46416489		
	Brava, Doblò, Palio, Palio Weekend, Marea, Marea Weekend, Siena e Strada (todos 1.6 16V)	
	Tensor da correia sincronizadora	
VKM 12299	7741	F-110806.2
Nº original 46736886		
	Fiorino, Idea, Palio, Palio Weekend, Punto, Siena, Strada, Uno (todos motor Fire 1.0, 1.3 e 1.4 8V)	
	Tensor da correia sincronizadora	

VKM 15216 L	7723 CP	F-232481
Nº original 7083589		
	Stilo 1.8 16V	
	Tensor da correia sincronizadora	

VKM 15402 L	7796	F-234394
Nº original 7085784		
	Palio, Palio Weekend, Strada, Siena, Stilo, Doblò, Idea, Punto e Linea (todos 1.8 8V)	
	Tensor da correia sincronizadora	

Polias e tensores de correias

Principais aplicações

Produtos equiv. | NYTRON | INA

VKM 22174 | 1136 |

Nº original 7763644



Marea 2.0 20V, Marea 2.0 20V Turbo, Marea 2.4 20V e Stilo 2.4 20V

Polia da correia sincronizadora

VKM 22177 | 1232 | F-231098

Nº original 60671573



Brava 1.8 16V 10/95...10/01 e Marea 1.8 16V 09/96...03/04

Polia da correia sincronizadora

NOVO

VKM 22242 A | 2054 | F-110628.3

Nº original 46400054 / 46554826



Brava, Doblò, Palio, Palio Weekend, Marea, Marea Weekend, Siena e Strada (todos 1.6 16V)

Polia da correia sincronizadora

VKM 25150 H | 2040 | F-224967

Nº original 7083886



Stilo 1.8 16V

Rolo guia da correia sincronizadora (52,5 mm)

VKM 25152 H | 2039 | F-224971

Nº original 7083485



Stilo 1.8 16V

Rolo guia da correia sincronizadora (63 mm)

VKM 32001 | 1248 |

Nº original 60812515 / 73501924



Brava HGT, Coupé 1.8 16V 03/96...05/98 e Marea (todos 1.8 16V com AC)

Polia da correia de serviço

NOVO

Produtos equiv. | NYTRON | INA

VKM 32002 | 1137 |

Nº original 7740252



Coupé 2.0 20V 04/98..., 2.0 20V e 2.0 20V Turbo 08/96..., Marea 2.0 20V 09/96... e Stilo 2.4 20V 10/01... (todos com AC)

Polia da correia de serviço

VKM 32005 H | 1144 | F-110672-300

Nº original 46440604



Coupé 2.0 20V 04/98... e 2.0 20V Turbo 09/96..., Palio/Palio Weekend 1.0/1.5 8V, Siena 1.0/1.5 96..., Marea/Marea Weekend 2.0 20V 09/96...04/99, Strada 1.5 8V (todos sem AC)

Polia da correia de serviço

VKM 32009 | 1142 |

Nº original 7702173



Uno 1.4 MPI Turbo; Palio/Palio Weekend/Siena (todos 1.6 16V 98...); Tipo 1.6 8V 93...95

Polia da correia de serviço

VKM 32015 | 1233 | F-123800

Nº original 46441096 / 7778564



Coupé 2.0 20V 04/98... e 2.0 20V Turbo 09/96..., Marea/Marea Weekend 2.0 20V 09/96...04/99 (todos sem/com AC)

Tensor da correia de serviço

NOVO

VKM 32022 | 1245 |

Nº original 46524692



Brava HGT, Coupé 1.8 16V 03/96...05/98 e Marea (todos 1.8 16V com AC)

Tensor da correia de serviço

NOVO

VKM 4592 | 1167 |

Nº original 46524820



Uno 1.0 8V 99... e 1.3 8V 01..., Fiorino 1.5 8V 97..., Palio 1.0 8V 98..., Palio/Palio Weekend/Siena 1.5 8V 99..., Strada 1.5 8V 02...





Polia da correia do alternador





FIAT - Continuação

FIAT - Continuação

Polias e tensores de correias







Principais aplicações





	Produtos equiv.	NYTRON	INA
VKM 4594 Nº original 46548452 / 46756902	7822		
	Doblò, Fiorino, Idea, Palio, Palio Weekend, Punto, Siena, Strada, Uno (todos motor Fire 8V/16V)		
	Tensor do alternador		
VKM 4614 Nº original 46524820	7785		
	Uno 1.3 8V 01..., Uno Mille 1.0 8V 99... e 1.5 8V 04...04, Palio 1.0 8V 98...02, 1.3 8V 03... e 1.5 8V 99..., Palio Weekend 1.5 8V 99...00, Siena 1.5 8V 99..., Fiorino 1.3 8V 97... e 1.5 8V 97... e Strada 1.5 8V 99...		
	Tensor da correia de serviço		
VKM 4753 Nº original 551920180 / 552013640	7795		
	Stilo, Punto e Idea (1.8 8V/16V motor GM)		
	Polia da direção hidráulica		
VKM 4754 Nº original 552013640	7709		
	Doblò, Idea e Punto (todos 1.8 8V)		
	Polia da correia do alternador		
VKM 4806 Nº original 46756937	1143	F-565353	
	Doblò, Fiorino, Idea, Palio, Palio Weekend, Punto, Siena, Strada, Uno (todos motor Fire 8V/16V)		
	Polia do alternador		
VKM 4810 Nº original 73500717	1178		
	Stilo 1.8 8V, 1.8 16V e 2.4 20V (com DH)		
	Polia (sem suporte) do alternador		

	Produtos equiv.	NYTRON	INA
VKM 4812 Nº original 46460702	1239		
	Marea 2.0 turbo		
	Polia do alternador		
VKM 4813 Nº original 73500717	7858		
	Stilo 1.8 8V, 1.8 16V e 2.4 20V (com DH)		
	Tensor do alternador		
VKM 4822 Nº original 55193730/55193452	1133		
	Punto, Palio/Palio Weekend/Siena/Strada 03..., Doblò, Idea (todos 1.8 8V inclusive Palio 1.8R)		
	Polia do tensor do alternador		
VKM 4841 Nº original 60652477	7734		
	Brava 1.8 16V 10/95...10/01 e Marea 1.8 16V 09/96...		
	Tensor da correia sincronizadora		
VKM 60001 A Nº original 98448218	1129		
	Ducato 2.8 e 2.8T		
	Polia do tensor do alternador		
VKM 60006 A Nº original 4427068	7786CS		
	Uno Mille (91...93), Uno 1.3 (85...91), Uno 1050 (85...87), 147, Panorama e Fiorino (88...93)		
	Polia da correia sincronizadora		

Polias e tensores de correias

Principais aplicações

	Produtos equiv.	NYTRON	INA
VKM 11000 H	7782	F-217668.05 F-217668.2C	
Nº original 026 109243 / 026 109243 E			
	Belina II, Del Rey, Pampa, Versailles, Versailles Royale, Escort e Verona (todos motor AP 1.8 /2.0 8V)		
	Polia da correia sincronizadora		
VKM 14210	1258	F-140221	
Nº original 928M 6K254 AC			
	Escort (motor Zetec 1.8 16V) 09/96...10/02, Mondeo 07/94...08/96 (todos) e 09/96...04/98 (motor Zetec-E 2.0)		
	Tensor da correia sincronizadora		
VKM 24210 H	1260	F-140222	
Nº original 928M 6M250 BC			
	Escort (motor Zetec 1.8 16V) 09/96...10/02, Mondeo 07/94...08/96 (todos) e 09/96...04/98 (motor Zetec-E 2.0)		
	Polia superior da correia sincronizadora		
VKM 24211 H	1259	F-140223	
Nº original 928M 6M250 DC			
	Escort (motor Zetec 1.8 16V) 09/96...10/02, Mondeo 07/94...08/96 (todos) e 09/96...04/98 (motor Zetec-E 2.0)		
	Polia inferior da correia sincronizadora		
VKM 34010	7867		
Nº original 97BB 6A228 AG			
	Focus 08/00... (Zetec 1.8/2.0 16V), Mondeo 05/98...03/01 (Zetec-E 2.0 8V)		
	Tensor da correia de serviço		
VKM 4756	7776		
Nº original XS6E 19A216 CC			
	Ka, Fiesta e Courier 09/99... (todos Zetec Rocam com AC e sem DH)		
	Tensor do alternador		

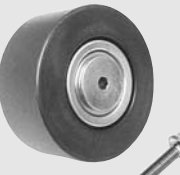



	Produtos equiv.	NYTRON	INA
VKM 4758	1116		
Nº original 2S65 19A216 AB			
	Fiesta 05/02... e Ecosport 02/03... (todos motor Zetec Rocam 1.0 Supercharger)		
	Polia da correia de serviço		
VKM 4767	1261		
Nº original BF6T 19W629 A/F87A 6A228 AA/3L55 6A228 AA			
	F1000 MWM Diesel e F4000 4.3T (todos 03/96...09/98), Ranger 11/97... (2.8 TD e 2.5D Power Stroke)		
	Polia do compressor do ar condicionado		
VKM 4769	7718		
Nº original 2RP 903157			
	Ônibus B1618 e B1621 03/93...08/98; F12000 e F14000 12/95...11/98 motor MWM 6.5		
	Tensor da correia do motor		
VKM 4770	7719		
Nº original T12 145275			
	F600 e F12000 (...92), Cargo 1313		
	Tensor da correia de serviço		
VKM 4771	7728		
Nº original T11 1452275 A / WD8T 10145 B			
	F1000 e F4000 (MWM com AC) 05/92...02/96; FT-7000 78...80, F-21000 81...85, F-22000 82...90, F-11000 01/90...03/92, F-14000 01/81...03/92, F-19000 81...82		
	Tensor da correia do motor		
VKM 4772	7773		
Nº original BF6T 2884 AA			
	F1000 e F4000 (MWM 4.3 03/96...09/98)		
	Polia do ventilador		

FORD







FORD - Continuação

Polias e tensores de correias

Principais aplicações

	Produtos equiv.	NYTRON	INA
VKM 4776 Nº original BG5T 10B300 AA	7811	F-565352	
 NOVO	Ranger 3.0 diesel eletrônico 02/05... Tensor do alternador		
VKM 4778 Nº original F77Z 6B209 AA / F37Z 6B209 A	7818		
 NOVO	Explorer 04/94...10/97 e Ranger 06/94...03/01 (todos 4.0 V6) Tensor da correia de serviço		
VKM 4781 Nº original BG2T 10B300 AA / BF5T 10B300 A	7832		
 NOVO	F1000 03/96...09/98 e Ranger 11/97... (2.5 e 2.8 Diesel Maxion) Tensor da correia de serviço		
VKM 4786 Nº original XS6E 19A216 BC / XS6E 19A216 BB	7775		
 NOVO	Fiesta, Ka, Novo Ka e Courier (1.0/1.6 SOHC Zetec Rocam sem AC/ sem DH) Tensor do alternador		
VKM 4788 Nº original BF7T 6B209 A + BF7T 6B209 B	7739	F-140070.1 F-140564.1	
 NOVO	F1000 02/96...09/98 motor Maxion, Ranger 11/97... motor 2.5/2.8D Tensor da correia sincronizadora		
VKM 4793 Nº orig. XS6E 19A216 CC/97BB 6A228 AG/1S7Q 6A228 AE/F77Z 6B209AG AA	1225		
 NOVO	Ka 08/99..., Fiesta e Courier 09/99... (todos Zetec Rocam com AC e sem DH); Mondeo 05/98...03/01 (Zetec-E 2.0 8V), Focus 08/00... (Zetec 1.8/2.0 16V); Mondeo 04/01...; Ecosport 01/03... (Duratec HE 2.0); Explorer 04/94...10/97 e Ranger 06/94...03/01 (OHV V6 4.0) Polia do tensor da correia de serviço		

FORD - Continuação





	Produtos equiv.	NYTRON	INA
VKM 4799 Nº original 928F 6A228 AB	7721		
 NOVO	Escort 09/96...10/02 (Zetec 1.8 16V) Tensor do alternador		
VKM 4823 Nº original 377 260299	1112		
 NOVO	Versailles/Royale 12/95...10/96 (transmissão por correia única Poly-V para DH e com AC) Polias do tensor da correia de serviço		
VKM 4824 Nº original 377 145299	1113		
 NOVO	Versailles/Royale 12/95...10/96 (transmissão por correia única Poly-V para DH e sem AC) Polias do tensor da correia de serviço		
VKM 4834 Nº original BF9T 19A216 BA	1128		
 NOVO	F250 11/00... com AC motor MWM Polia lisa do alternador		
VKM 4835 Nº original BF9T 19A216 AA	1222		
 NOVO	F250 03/99... sem AC motor MWM Polia estriada do alternador		
VKM 4836 Nº original BF8T 19A216 AA	1226		
 NOVO	F250 03/99...09/99 com AC motor MWM Polia lisa do alternador		

FORD - Continuação

Polias e tensores de correias

Principais aplicações

FORD - Continuação

Produtos equiv.	NYTRON	INA
VKM 4839	1160	F-235786.01
Nº original YS4E 19A216 AA		
	Ka (motor Endura-E com AC) 02/97...07/99, Escort (motor Zetec 1.8 16V) 09/96...10/02, Fiesta (motor Endura-E com DH e Zetec-SE 1.4 16V) 05/96...08/99 e Courier (motor Endura-E com DH e Zetec-SE 1.4 16V) 07/97...08/99	
NOVO	Polia da correia de serviço	
VKM 4840	7720	
Nº original 988M 6K254 AD / 988M 6K254 AC		
	Focus Zetec 1.8/2.0 16V 08/00... e Mondeo Zetec-E 2.0 06/98...03/01	
NOVO	Tensor da correia sincronizadora	
VKM 4842	7826	
Nº original 96BF 6A228 AB		
	Ka 02/97..., Fiesta 05/96... e Courier 07/97... (todos ...08/99 motor Endura-E com DH)	
NOVO	Tensor do alternador	
VKM 60001 A	1129	
Nº original 928 6A228 AB/BF9T 10B300 AA		
	Escort (1.8 16V Zetec) 09/96...11/02 e F-250 MWM 10/00...	
	Polia do tensor do alternador	

GM







VKM 15121 L	7792	F-232482
Nº original 09202478 / 90499401		
	Corsa 1.0, 1.4 e 1.6 8V (...05 inclui motor VHC); Celta (01...05 1.0 e 1.4 8V)	
	Tensor da correia sincronizadora	
VKM 15202 L	7797	F-232488
Nº original 09158004 / 90530125		
	Astra e Zafira (2.0 16V), Calibra 94...95 após motor 14002935, Vectra 97...(2.0 16V)	
	Tensor da correia sincronizadora	







GM - Continuação

Produtos equiv.	NYTRON	INA
VKM 15211		
Nº original 90323501		
	Calibra (94...95 até motor 14142838 com correia de 141 dentes)	
NOVO	Tensor da correia sincronizadora	
VKM 15216 L	7723 CP	F-232481
Nº original 09128516 / 93304891		
	Corsa e Tigra 16V; Astra 1.6/1.8 16V e Meriva 1.8 16V	
	Tensor da correia sincronizadora	
VKM 15402 L	7796	F-234394
Nº original 09158003		
	Astra/Zafira 1.8/2.0 8V; Kadett/Ipanema 8V (95...98), Monza 96, Omega/Suprema (2.0/2.2 8V 93...98); S10/Blazer 4x2 2.2 e 2.4 95...; Vectra 8V; Corsa e Meriva 04... 1.8 8V; Corsa/Corsa Classic 1.0/ 1.4/1.6 8V (06... inclui motor VHC); Celta (06... 1.0 e 1.4 8V), Montana 04... (1.4/1.8 8V), Prisma 1.4 8V 06...	
	Tensor da correia sincronizadora	
VKM 25150 H	2040	F-224967
Nº original 09128740		
	Corsa/Tigra 16V; Astra 1.6/1.8 16V e Meriva 1.8 16V	
	Rolo guia da correia sincronizadora (52,5 mm)	
VKM 25152 H	2039	F-224971
Nº original 09128739		
	Corsa/Tigra 16V; Astra 03... 1.6/1.8 16V e Meriva 1.8 16V	
	Rolo guia da correia sincronizadora (63 mm)	
VKM 25211		
Nº original 90323503		
	Calibra (94...95 até motor 14142838 com correia de 141 dentes)	
NOVO	Polia da correia sincronizadora	

Polias e tensores de correias



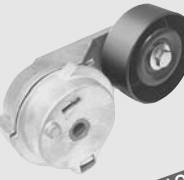



Principais aplicações

	Produtos equiv.	NYTRON	INA
VKM 25212 H Nº original 09128738	2041	F-224964	
	Calibra 94...95 a partir motor 14142839 com correia 176 dentes, Vectra todos 16V (polia 52,5 mm)		
	Polia da correia sincronizadora		
VKM 25213 H Nº original 90411773	2038	F-224966	
	Calibra 94...95 a partir motor 14142839 com correia 176 dentes e Vectra 2.0 16V 94...96 (polia 62,7 mm)		
	Polia da correia sincronizadora		
VKM 25224 Nº original 90529810	2042	F-231413	
	Astra/Zafira 2.0 16V 99..., Vectra 2.4 16V Flex 06...		
	Polia da correia sincronizadora		
VKM 35002 H Nº original 93297272 / 90409238	1223	F-110811.2	
	Corsa, Celta e Omega/Suprema 3.0 93...94 (todos com AC)		
	Polia do alternador		
VKM 35008 L Nº original 90411025	7817		
	Celta, Corsa e Prisma (todos 1.0 8V e 1.4 8V sem AC e com DH)		
	Tensor da correia da direção hidráulica		
VKM 35009 L Nº original 90500229 / 90502129 / 93375464	7815/7816	F-235783 F-235784	
	Astra (com DH), Zafira, Calibra 94...95 a partir motor 14142839, Celta (com AC) e Corsa (com AC exceto 1.8 8V/16V), Omega 2.2, Novo Vectra, Vectra GT, Vectra (70/120 A)		
	Tensor da correia da direção hidráulica		

	Produtos equiv.	NYTRON	INA
VKM 4752 Nº original 93384813 / 93374496	7814		
	Corsa 02..., Meriva e Montana (todos 1.8 8V/16V)		
	Tensor da direção hidráulica		
VKM 4753 Nº original 93302612 / 94700296	7795		
	Corsa 02..., Meriva 04...e Montana (1.8 8V/16V) e Vectra 97... (2.0/2.2 8V/16V), Astra 1.8/2.0 8V 04...		
	Polia da direção hidráulica		
VKM 4775 Nº original 10239670 / 12456152 / 12580296 / 89017309	7808		
	Blazer e S10 4.3 MPFI		
	Tensor do alternador		
VKM 4777 Nº original MWM 34101	7812		
	Silverado e Gran Blazer (4.2 Diesel 97...01), GMC 6-100/6-150		
	Tensor do alternador		
VKM 4779 Nº original 93258289	7820		
	Blazer e S10 (00... 2.2/2.4)		
	Tensor da direção hidráulica		
VKM 4781 Nº original 70520171 / 70992880	7832		
	Blazer e S10 (2.5 HSD Maxion)		
	Tensor do alternador		

Polias e tensores de correias

Principais aplicações





	Produtos equiv.	NYTRON	INA
VKM 4788 Nº original ETC 8560 A	7739	F-140070.1 F-140564.1	
 NOVO	Blazer e S10 96...00 (todos motor 2.5 HSD Maxion)		
	Tensor da correia sincronizadora		
VKM 4793 Nº original 10329670 / 12456152	1225		
 NOVO	Blazer e S10 4.3 96...		
	Polia do alternador		
VKM 4794 Nº original 93374496	1139		
 NOVO	Corsa 02..., Meriva e Montana (todos 1.8 8V/16V)		
	Polia do alternador		
VKM 4810 Nº original 90571758	1178		
 NOVO	Astra 03... 1.6 16V, Corsa 02... e Meriva 04... (com DH eletrônica modulada)		
	Polia do tensor do alternador		
VKM 4813 Nº original 90571758	7858		
 NOVO	Astra 03... 1.6 16V, Corsa 02... e Meriva 04... (com DH eletrônica modulada)		
	Tensor do alternador		
VKM 4834 Nº original 9 407 0 380 002 4	1128		
 NOVO	Blazer e S10 2.8 turbo 00... com AC		
	Polia do alternador		

	Produtos equiv.	NYTRON	INA
VKM 4835 Nº original 9 407 0 381 009 4 / MSB 38103	1222		
 NOVO	Blazer e S10 motor 2.8 turbo aftercooler 00... (motor MWM diesel)		
	Polia estriada da correia de serviço		
VKM 4836 Nº original 9 407 0 380 001 4 / MSB 38001	1226		
 NOVO	Blazer e S10 motor 2.8 turbo aftercooler 00... (motor MWM diesel)		
	Polia lisa da correia de serviço		
VKM 4845 Nº original 90528603			
 NOVO	Astra 04...(2.4 16V), Vectra 98...(2.2 16V)		
	Tensor da correia sincronizadora		
VKM 60001 A Nº original 90500229 / 90502129	1129		
 NOVO	Astra e Calibra 2.0 16V, Celta e Corsa com AC, Omega 2.2 8V 95...00		
	Polia do tensor do alternador		
VKM 60004 A Nº original 08966821 / 09275148	7783	F-44818	
 NOVO	Chevette, Chevy 500, Marajó (todos)		
	Polia da correia sincronizadora		
VKM 60005 A Nº original 52251292 / 70670195 / 70810058	7784	F-44818.2	
 NOVO	Monza, Kadett e Ipanema 91...93 (2.0 com DH e AC); S10 / Blazer 2.5 Maxion (96...00), 2.2 EFI (95...97), 2.2 MPFI 98...99 (com DH e AC)		
	Polia do compressor		



Polias e tensores de correias

Principais aplicações

GM - Continuação

Produtos equiv.	NYTRON	INA
VKM 60007 A	7790	F-550461
Nº original 93202400		
Monza/Kadett/Ipanema (89...95); Omega 8V 1995; Vectra 2.0 8V (95...96)		
		
Tensor da correia sincronizadora		
VKM 60012 A	1166	
Nº original 93214266		
Silverado, Gran Blazer, 3500 HD (97...99); Omega e Suprema 4.1 (95...98)		
		
Polia do alternador		
VKM 60013 A	7819	
Nº original 940703410074		
Blazer e S10 (2.8 Turbodiesel)		
		
Tensor da correia da direção hidráulica		
VKM 60014 A	1171	
Nº original 93336184		
Astra (00...03 AC + DH)		
		
Polia da correia da direção hidráulica		



HONDA

VKM 4797	7756	
Nº original 04145-PLC-315		
Civic 1.7 16V 01...		
		
Tensor da correia sincronizadora		
VKM 73000		
Nº original 14510-PM7-003/-004		
Civic 1.6 imp. (LX 93...95)		
		
Tensor da correia sincronizadora		

HONDA - Continuação

Produtos equiv.	NYTRON	INA
VKM 73005		
Nº original 14510-P08-003/-004		
Civic 1.5 01/92...08/99 e 1.6 (Vtec)		
		
Tensor da correia sincronizadora		
VKM 73011		
Nº original 13404-PT0-003/-004		
Accord 2.0 e 2.3 (...00) e 2.2 (90...97)		
		
Polia da correia sincronizadora		
VKM 73201		
Nº original 14510-P30-003/14510-PR3-003/-004		
Civic 1.6 VTI imp. (comando duplo ...98)		
		
Tensor da correia sincronizadora		
VKM 73600		
Nº original 13404-PT0-003/-004		
Accord 2.0 e 2.3 (...00) e 2.2 (90...97)		
		
Tensor da correia sincronizadora		





HYUNDAI

VKM 75004	7777	
Nº original 24410-35020		
Galopper 3.0 01/92...11/02, Sonata 2.0 16V 05/91...10/94 e 3.0 8V 01/91...10/94		
		
Tensor da correia sincronizadora		
VKM 75044	2055	
Nº original 23357-33120		
Elantra 1.6 16V 07/92... e 1.8 16V 06/92..., Sonata 2.0 16V 05/91... (todos ...09/94)		
		
Polia tensora da correia sincronizadora		

Polias e tensores de correias

Principais aplicações





HYUNDAI - Continuação

Produtos equiv.	NYTRON	INA
VKM 75144	2049	
Nº original 24450-33010/-33020		
	Elantra 1.6 16V 07/92... e 1.8 16V 06/92..., Sonata 2.0 16V 05/91... (todos ...09/94)	
NOVO	Polia tensora da correia sincronizadora	
VKM 75601	7789	F-124070
Nº original 24317-42020		
	H100 2.5D 07/93...03/94, Galloper 2.5 TD 01/98...11/02	
	Tensor da correia sincronizadora	
VKM 75612	7757	F-124052
Nº original 23357-42030		
	H100 2.5D 07/93...03/94, Galloper 2.5 TD 01/98...11/02	
	Tensor da correia sincronizadora	
VKM 85000	2052	
Nº original 24810-38001		
	Elantra 1.6 16V 07/92... e 1.8 16V 06/92..., Sonata 2.0 16V 05/91... (todos ...09/94)	
NOVO	Polia da correia sincronizadora	



IVECO - FIAT

VKM 22380	7751	
Nº original 4740847		
	Ducato (2.5D 08/90...04/02, 2.8 JTD 11/00...03/04)	
	Polia da correia sincronizadora	
VKM 22385	7752	F-113338
Nº original 0830.40 /99432547		
	Ducato 2.5D e 2.8 D/TD/Tdi, Daily 2.5 e 2.8	
	Polia da correia sincronizadora	

IVECO - FIAT - Cont.

Produtos equiv.	NYTRON	INA
VKM 4787	1234	
Nº original 98448218		
	Ducato 2.8 91... e Daily 2.8 turbo	
NOVO	Polia do alternador	
VKM 74004	1158	
Nº original K016-12-700		
	Besta e Sportage 05/93...10/94 (todos 2.2D)	
	Tensor da correia sincronizadora	
VKM 74600		
Nº original OK972-12-700 / FE1H-12-700 A		
	Sportage 2.0 8V 4x4 05/93...12/96 e 2.0 16V 4x4 04/94...12/96	
NOVO	Tensor da correia sincronizadora	
VKM 84601		
Nº original FE3N-12-730		
	Sportage 2.0 8V 4x4 05/93...12/96 e 2.0 16V 4x4 04/94...12/96	
NOVO	Polia da correia sincronizadora	



MAZDA

VKM 74002		
Nº original FS01-12-700 A/ FS05-12-700 A		
	626 05/97...11/99 DOHC	
NOVO	Tensor da correia sincronizadora	
VKM 74600		
Nº original OK972-12-700 / FE1H-12-700 A		
	626 2.0 16V 06/87...12/94	
NOVO	Tensor da correia sincronizadora	





Polias e tensores de correias

Principais aplicações





MAZDA - Continuação

Produtos equiv.	NYTRON	INA
VKM 84000		
Nº original FS01-12-730 A		
626 05/97...11/99 DOHC		
	Polia da correia sincronizadora	
VKM 84601		
Nº original FE3N-12-730		
626 2.0 16V 06/87...12/94		
	Polia da correia sincronizadora	

MBB

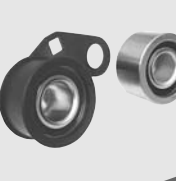
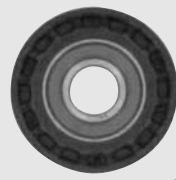
VKM 4763	1224	
Nº original 000 550 0633		
1938 e 2638 (motor OM 457)		
	Polia da correia do ventilador	
VKM 4766	1253	
Nº original 611 234 0393		
Sprinter (motor CDI Eletrônico)		
	Polia do tensor da correia	
VKM 4781	7832	
Nº original 000 200 0970		
Sprinter 2.5 HSD Maxion		
	Tensor do alternador	
VKM 4783	7834	
Nº original 457 200 1770		
1938 e 2638 (motor OM 447 e OM 457)		
	Tensor do alternador	

MBB - Continuação

Produtos equiv.	NYTRON	INA
VKM 4784	7835	
Nº original 906 200 2070		
1938 e 2638 (motor OM 457); 712, 715 e 914 (motor OM 906)		
	Tensor da correia do motor	
VKM 4788	7739	F-140070.1 F-140564.1
Nº original 000 030 0069		
Sprinter (todos motor 2.5 HSD Maxion)		
	Tensor da correia sincronizadora	
VKM 4795		
0500 98... (Motor OM 457 LA)		
	Polia da correia de serviço	
VKM 4796		
Atego, Accelo, Axor, BR 900, 904, 906, 920, 924, 926 03...		
	Polia da correia de serviço	
VKM 4798		
Nº original 906 200 4570		
Atego, Accelo, Axor, BR 900, 904, 906, 920, 924, 926 (03...)		
	Tensor da correia serviço	
VKM 4810	1178	
Nº original 166 202 0519		
Classe A 1.6 e 1.9		
	Polia do tensor do alternador	

Polias e tensores de correias

Principais aplicações

MBB - Continuação

VKM 4818	Produtos equiv. NYTRON INA
Nº original 611 200 0570	7865



Sprinter CDI Eletrônico

NOVO Tensor da correia do motor

VKM 75000	2058
Nº original MD 140071	



Galant 2.5 24V 11/92...04/95, Pajero 3.5 24V ...00, Pajero Sport 3.0 24V 11/98...12/02

NOVO Polia da correia sincronizadora

VKM 75004	7777
Nº original MD 104578	



Pajero 3.0 12/90...05/94, L200 3.0 4x4 06/89...12/94

NOVO Tensor da correia sincronizadora

MITSUBISHI

VKM 75009	2050
Nº original MD 169592	



Colt 1.6 16V 11/95...12/96 e 1.8 16V 04/92...11/94; Lancer 1.6 16V 12/95...01/01 e 1.8 16V 12/91...11/94; Pajero 1.8 16V

NOVO Polia da correia sincronizadora

VKM 75044	2055
Nº original MD 115976	

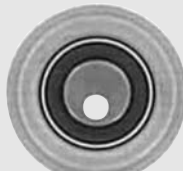

Eclipse 2.0 04/91...02/93, Galant 2.0 16V 11/89...12/92

NOVO Tensor da correia sincronizadora

VKM 75064	2051
Nº original MD 182537	



Space Wagon 2.4 16V 12/98...12/02

NOVO Tensor da correia sincronizadora

VKM 75601	Produtos equiv. NYTRON INA
Nº original MD 050135	7789 F-124070



L200 e L300 2.5D ...12/96, Pajero 2.5D e 2.5 TD ...05/94

Tensor da correia sincronizadora

VKM 75612	7757 F-124052
Nº original MD 050125	



L200 e L300 2.5D ...12/96, Pajero 2.5D e 2.5 TD ...05/94

Tensor da correia sincronizadora

MITSUBISHI - Continuação

VKM 75613	
Nº original MD 315265	



Space Wagon 2.4 16V 12/98...12/02

NOVO Tensor da correia sincronizadora

VKM 85000	2052
Nº original MD 121993 / MD 156604	



Colt 1.6 16V 11/95...12/96 e 1.8 16V 04/92...11/94; Lancer 1.6 16V 12/95...01/01 e 1.8 16V 12/91...11/94; Pajero 1.8 16V; Eclipse 2.0 04/91...02/93, Galant 2.0 16V 11/89...12/92; Space Wagon 2.4 16V 12/98...12/02

NOVO Polia da correia sincronizadora

VKM 85002	2059
Nº original MD 319022	



Galant 2.5 24V 11/92...04/95, Pajero 3.5 24V ...00, Pajero Sport 3.0 24V 11/98...12/02

NOVO Polia da correia sincronizadora

NISSAN

VKM 4834	1128
Nº original 940703410074	





Frontier e X-Terra 2.8 com AC

NOVO Polia da correia do alternador



Polias e tensores de correias

Principais aplicações







NISSAN - Continuação

Produtos equiv.	NYTRON	INA
VKM 4835	1222	
Nº original 940703810094		
	Frontier e X-Terra 2.8 com AC	
NOVO	Polia da correia do alternador	
VKM 60001 A	1129	
Nº original 940703800024		
	Frontier e X-Terra 2.8 turbo	
NOVO	Polia do tensor do alternador	
VKM 60013 A	7819	
Frontier e X-Terra 2.8TD		
	Tensor da correia do alternador	

PEUGEOT

Produtos equiv.	NYTRON	INA
VKM 13100	7772 / 7762	F-121287.5
Nº original 0829.19/0829.29		
	106 1.0 8V e 1.4 8V (TU3JP ...motor 3666765) ; 205 1.4 8V; 206 1.0 8V nac. e 1.6 8V imp.; 306 1.6, 1.8 e 2.0; Partner 1.8 8V XU7JB (05/97...)	
NOVO	Tensor da correia sincronizadora	
VKM 13132	7770	F-232829.5
Nº Original: 0829.82 / 0829.C7		
	206 e 307 (09/00...) e Partner (07/01...) todos motor 1.6 16V TU5JP4 até motor 1806404	
NOVO	Tensor da correia sincronizadora (73 mm)	
VKM 13202	7763	
Nº original 0829.32 / 0829.35		
	306 (03/96...), 406 (11/95...), 605 (07/94...09/99) (todos 2.0 16V motor XU10J4R/RS)	
NOVO	Tensor da correia sincronizadora	

PEUGEOT - Continuação

Produtos equiv.	NYTRON	INA
VKM 13210	7760	
Nº original 0829.20 / 91538722		
	306 (05/93...), 405 (08/92...10/95) (todos 2.0 16V motor XU10J4)	
NOVO	Tensor da correia sincronizadora	
VKM 13211	7761	
Nº original 0829.46 / 96137001		
	306 (05/93...), 405 (08/92...10/95) (todos 2.0 16V motor XU10J4)	
NOVO	Tensor da correia sincronizadora	
VKM 13214	7778	
Nº original 0829.69		
	306 (03/97...) (todos 1.8 16V motor XU7JP4)	
NOVO	Tensor da correia sincronizadora	
VKM 13234	7771	
Nº original 0829.96		
	307 (08/00...), 406 (01/99...) e 407 (05/04...) (todos 2.0 16V motor EW10J4)	
NOVO	Tensor da correia sincronizadora	
VKM 13256		
Nº Original: 0829.A0 / 0829.C8		
	206 e 307 (09/00...) e Partner (07/01...) todos motor 1.6 16V TU5JP4 a partir motor 1806405	
NOVO	Tensor da correia sincronizadora (70 mm)	
VKM 13902		
Nº original 0829.10		
	406 (10/96...) e 407 (05/04...) (todos com motor 3.0 V6 ES9J4S)	
NOVO	Tensor da correia sincronizadora	

Polias e tensores de correias

Principais aplicações

Produtos equiv. | NYTRON | INA

VKM 22380 | 7751

Nº original 0830.32



Boxer 2.5 D 03/94...04/02 e 2.8 D/TD/Hdi 11/00... (todos com motor Sofim)

Polia da correia sincronizadora

VKM 22385 | 7752 | F-113338

Nº original 0830.40



Boxer 2.5 D 03/94...04/02 e 2.8 D/TD/Hdi 11/00... (todos com motor Sofim)

Polia da correia sincronizadora

VKM 23130 | 1251 | F-122574.5

Nº Original: 0830.20 / 0830.61



206 e 307 (09/00...) e Partner (07/01...) todos motor 1.6 16V TU5JP4 até motor 1806404

Polia da correia sincronizadora (57 mm)

VKM 23213 H | | |

Nº original 0830.14



306 (03/96...), 406 (11/95...), 605 (07/94...09/99) (todos 2.0 16V motor XU10J4R)

Polia da correia sincronizadora

VKM 23214 | 7764

Nº original 0830.11 / 0830.14 / 0830.37



306 (03/97...) (todos 1.8 16V motor XU7JP4)

Polia da correia sincronizadora

VKM 23230 | 1280

Nº original 0830.42



307 (08/00...), 406 (01/99...) e 407 (05/04...) (todos 2.0 16V motor EW10J4 e EW10A)

Polia da correia sincronizadora

Produtos equiv. | NYTRON | INA

VKM 23256 | | |

Nº Original: 0829.A1 / 0830.62

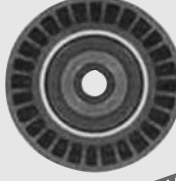

206 e 307 (09/00...) e Partner (07/01...) todos motor 1.6 16V TU5JP4 a partir motor 1806405

Polia da correia sincronizadora (60 mm)

VKM 23900 | | |

Nº original 0830.24 / 0830.26 / 0830.53

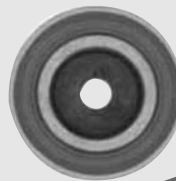

406 (10/96...) e 407 (05/04...) (todos com motor 3.0 V6 24V ES9J4 e 3.0 V6 ES9J4S)

Polia da correia sincronizadora

VKM 23901 | | |

Nº original 0830.25 / 0830.27 / 0830.54



406 (10/96...) e 407 (05/04...) (todos com motor 3.0 V6 24V ES9J4 e 3.0 V6 ES9J4S)

Polia da correia sincronizadora

VKM 33003 | | |

Nº original 5751.18



306 (1.8 8V e 1.8 16V, 2.0 16V), 405 (1.6 8V, 1.8 8V e 2.0 8V), 605 2.0 16V e 806 2.0 Turbo (todos sem AC motores XU7JB, XU7JP4, XU7JP, XU10J2C, XU10J4, EW10JP4)

Tensor da correia de serviço

VKM 33012 | | |

Nº original 6453.55



106 1.0 TU9M 09/91..., 1.4 TU3M 09/91...04/96 TU3JP 05/96... com ch 50986718..., 1.5 TUD5 06/94...04/96; 205 1.4 TU3JP/TU3M 01/95...09/98; 306 1.6 TU5JP 01/95...10/00 com DH (todos com AC)

Tensor da correia de serviço

VKM 33023 | 1239

Nº original 5751.52









206 1.4 8V TU3JP 09/98...04/02, 1.6 8V TU5JP 09/98...12/00 e 1.6 16V TU5JP4 09/00...04/02 (todos com AC/com DH)

Polia da correia de serviço





Polias e tensores de correias

Principais aplicações

PEUGEOT - Continuação

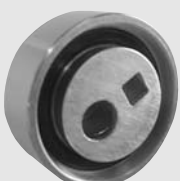
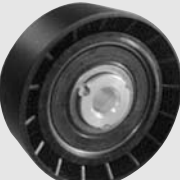
Produtos equiv.	NYTRON	INA
VKM 33037	1244	
Nº original 5751.53		
	206 1.4 8V TU3JP 09/98...04/02, 1.6 8V TU5JP 09/98...12/00 e 1.6 16V TU5JP4 09/00...04/02 (todos com AC/com DH)	
NOVO	Tensor da correia de serviço	
VKM 33074		
Nº original 5751.91		
	307 (todos 1.6 16V motor TU5JP4/EJEJ4)	
NOVO	Polia da correia de serviço	
VKM 33101	1123	
Nº original 5751.A7		
	206 1.4 8V TU3JP 05/02... e 1.6 16V TU5JP4 (05/02...) (todos com AC/com DH)	
NOVO	Tensor da correia de serviço	
VKM 4617	7769	F-236389
Nº original 0829.86		
	206 (1.0 16V motor D4D)	
	Tensor da correia sincronizadora	
VKM 4759	7726	
Nº original 0829.90		
	106 (05/96...) e 206 (09/98...) (todos motor TU3JP 1.4 8V correia de 104 dentes mot 3666766...)	
NOVO	Tensor da correia sincronizadora	
VKM 4789	1250	
Nº original 5751.98		
	206 1.6 16V 01... e 206 1.4 8V	
NOVO	Polia da correia do alternador	

PEUGEOT - Continuação







Produtos equiv.	NYTRON	INA
VKM 4791	1262	
Nº original 5751.50		
	206 (com AC/sem DH ou sem AC/com DH 1.4 8V TU3JP, 1.6 8V TU5JP e 1.6 16V TU5JP4)	
NOVO	Tensor da correia de serviço	
VKM 4800	7762	F-121287.5
Nº original 97535002 / 0829.19 / 0829.29		
	106 1.0 8V e 1.4 8V; 205 1.4 8V; 206 1.0 8V nacional e 1.6 8V importado; 306 1.6, 1.8 e 2.0; Partner 1.8 8V (05/97...)	
NOVO	Tensor da correia sincronizadora	
VKM 4807	1150	
Nº original 4003.A3 / 8200040161		
	206 1.0 16V (com DH)	
NOVO	Polia da correia do alternador	
VKM 13902		
Laguna 03/97...06/04 motor 3.0 V6		
		
NOVO	Tensor da correia sincronizadora	
VKM 16000	1149	F-123958
Nº original 7700736085		
	Mégane e Scénic 1.6 8V (motor K7M), Twingo 1.0 8V (motor D7D) e 1.2 8V (motor D7F), Clio 1.0 8V (motor D7D)	
NOVO	Polia da correia sincronizadora	
VKM 16020 L	7759	F-550228
Nº original 7700108117 / 8200244615		
	Clio, Kangoo, Megane e Scénic (motor K4M 1.6 16V), Logan e Sandero (1.6 16V)	
NOVO	Tensor da correia sincronizadora	

RENAULT







Polias e tensores de correias

Principais aplicações

RENAULT - Continuação





Produtos equiv.	NYTRON	INA
VKM 16101 H	1256	
Nº original 7700726440		
	Laguna, Mégane e Scénic (todos 2.0 8V motor F3R); R19 (1.8 8V motor F3P)	
Tensor da correia sincronizadora		
VKM 16112 H	F-120180	
Nº original 7700736419		
	Mégane e Scénic (motor F7R 2.0 16V), R19 (motor 1.8 16V)	
Tensor da correia sincronizadora		
VKM 16200		
Nº original 7700692315		
	R 21 e Trafic (2.0 8V motor J6R, 2.0 8V Turbo motor J7R e 2.2 8V motor J7T ...mot. F241442)	
Tensor da correia sincronizadora		
VKM 16204		
Nº original 7700745215 / 7700871168		
	Trafic 2.2 8V motor J7T mot F241443...	
Tensor da correia sincronizadora		
VKM 16212		
Nº original 7700852114 / 7700871169		
	Trafic 2.1 diesel	
Tensor da correia sincronizadora		
VKM 16550 A	7768	
Nº original 7700114860 / 8200061345 / 7700102872		
	Laguna, Mégane e Scénic (todos 2.0 16V motor F4R)	
Tensor da correia sincronizadora		

RENAULT - Continuação

Produtos equiv.	NYTRON	INA
VKM 16602		
Nº original 7439146139		
	Laguna (06/95...03/01 2.0 16V)	
Tensor da correia sincronizadora		
VKM 22380	7751	
Nº original 7431275380		
	Master 2.5D e 2.8D (1 peça para correia 152 dentes)	
Polia da correia sincronizadora		
VKM 22385	7752	F-113338
Nº original 7701040204		
	Master 2.5D e 2.8D (1 peça para correia 152 dentes ou 2 peças para correia de 154 dentes)	
Polia da correia sincronizadora		
VKM 23900		
Nº original 9616660780		
	Laguna 03/97... motor 3.0 V6	
Polia da correia sincronizadora		
VKM 23901		
Nº original 9616660780		
	Laguna 03/97... motor 3.0 V6	
Polia da correia sincronizadora		
VKM 26101 H	7767	
Nº original 7701469776		
	Laguna, Mégane e Scénic (todos 2.0 8V motor F3R); R19 (1.8 8V motor F3P)	
Polia da correia sincronizadora		

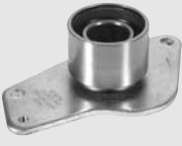
Polias e tensores de correias

Principais aplicações

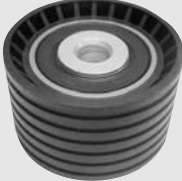





Produtos equiv.	NYTRON	INA
VKM 26102 H		
Nº original 7700733489		
	Mégane e Scénic (motor F7R 2.0 16V), R19 (motor 1.8 16V)	
Polia da correia sincronizadora		
VKM 26602		
Nº original 7439146376		
	Laguna (06/95...03/01 2.0 16V)	
Polia da correia sincronizadora		
VKM 36005		
Nº original 7700272972		
	Mégane 07/96...04/97 (motor K7M 1.6 8V DH+AC)	
Tensor da correia de serviço		
VKM 36010	7780	
Nº original 7700862108		
	Mégane 01/96...06/96 (motor K7M 1.6 8V AC+DH)	
Tensor da correia serviço		
VKM 36013	1145	F-120850
Nº original 7700850603		
	Clio (1.0 16V motor D4D); R19 (1.8 8V motor F3P); R 21 2.0/2.2 8V (todos com AC)	
Polia da correia de serviço		
VKM 4597	1156	
Nº original 7700107150		
	Clio, Kangoo, Megane e Scénic (motor K4M 1.6 16V); Laguna, Mégane e Scénic (motor F4R 2.0 16V)	
Polia da correia sincronizadora		

Produtos equiv.	NYTRON	INA
VKM 4599	1182	
Nº original 8200064664		
	Laguna, Mégane e Scénic (todos motor F4R 2.0 16V)	
Polia da correia sincronizadora		
VKM 4611	1153	
Nº original 7700111822		
	Laguna, Mégane e Scénic (todos 2.0 16V motor F4R)	
Polia da correia sincronizadora		
VKM 4617	7769	F-236389
Nº original 8200103069		
	Clio e Kangoo (motor D4D 1.0 16V), Twingo motor D4F 1.2 16V	
Tensor da correia sincronizadora		
VKM 4773	1148	F-123154.3
Nº original 7700273277 / 8200102612		
	Clio, Kangoo e Mégane (todos motor K7M 1.6 8V)	
Polia da correia sincronizadora		
VKM 4792	1235	F-121366
Nº original 7700851321		
	Laguna, Mégane e Scénic (todos motor F3R 2.0 8V com AC); R19 (motor F7P 1.8 16V)	
Polia do alternador		
VKM 4801	1147	
Nº original 7700875325 / 8200192843		
	Clio, Kangoo e Scénic (1.6 8V motor K7M e 1.6 16V motor K4M) todos sem AC	
Tensor do alternador		

Polias e tensores de correias

Principais aplicações

RENAULT - Continuação

Produtos equiv.	NYTRON	INA
VKM 4802	1151	F-124059
Nº original 7700102931 / 7700102872		
	Clio, Kangoo, Mégane e Scénic (todos motor K4M 1.6 16V); Laguna, Mégane e Scénic (motor F4R 2.0 16V) todos com DH+AC; Laguna, Mégane, Scénic e Trafic (motor F3R 2.0 8V com AC)	
NOVO	Polia da correia de serviço	
VKM 4803	7765	
Nº original 7701468167		
	Laguna, Mégane e Scénic (todos 2.0 8V motor F3R); R19 (1.8 8V motor F3P)	
NOVO	Tensor da correia sincronizadora	
VKM 4807	1150	
Nº original 8200040161		
	Clio e Kangoo 1.0 16V, Twingo 1.2 8V (com DH e AC)	
NOVO	Polia da correia do alternador	
VKM 4808	1154	
Nº original 8200136224 / 8200040155		
	Clio 1.0 8V/16V 00... e Kangoo 1.0 16V; Twingo 1.0 8V/16V e 1.2 8V (motores D4D/ D7D/ D4F/ D7F) todos com AC	
NOVO	Polia do alternador	
VKM 4819	1230	
Nº original 7700875305		
	Laguna, Mégane e Scénic (todos 2.0 8V motor F3R)	
NOVO	Polia da correia sincronizadora	
VKM 4764	1242	
Nº original 1428940		
	P94, R114, T114, T124, R124 e K124 (todos com AC)	
NOVO	Polia do alternador	

SCANIA - Continuação

Produtos equiv.	NYTRON	INA
VKM 4765	1243	
Nº original 1428941		
	P94, R114, T114, R124 e K124 (todos sem AC)	
NOVO	Polia do alternador	
VKM 4782	7833	
Nº original 1503113		
	P94, R114, T114, T124, R124, K124	
NOVO	Tensor da correia do motor	
VKM 11000 H	7782	F-217668.05 F-217668.2C
Nº original 026 109243 / 026 109243 E		
	Cordoba, Cordoba GLX/SXE, Ibiza, Ibiza GLX/SXE (todos motor AP 1.6 8V e 1.8 8V)	
NOVO	Polia da correia sincronizadora	
VKM 11113	F-123814	
Nº original 06A 109479 A/C		
	Ibiza 1.6 8V 99...03	
NOVO	Tensor da correia sincronizadora	
VKM 31011 L		F-235782
Nº original 06A 903315 E		
	Cordoba e Ibiza (1.6 8V / 1.8 8V)	
NOVO	Tensor da correia de serviço	
VKM 31015 L	7799	F-235786.01
Nº original 030 145299 C/F		
	Ibiza 1.6 (com AC)	
NOVO	Tensor da correia de serviço	

SEAT

Polias e tensores de correias

Principais aplicações

SEAT - Continuação

VKM 4839	Produtos equiv. NYTRON INA
Nº original 030 145299 C/F	1160 F-235786.01



lbiza 1.0 e 1.6

Polia da correia de serviço

NOVO

VKM 78000		
Nº original 13069-AA034 / 035 / 036 / 037		



Impreza 1.6 93...11/94 e 1.8 11/92...95, Legacy 1.8 90...91 e 2.2 90...95

Tensor da correia sincronizadora

NOVO

SUBARU

VKM 88000		
Nº original 13073-AA081/-AA082/-AA-140/AA-142/AA-180		



Impreza 1.6 93...11/94 e 1.8 11/92...95, Legacy 1.8 90...91 e 2.2 90...95

Polia da correia sincronizadora

NOVO

VKM 88001		
Nº original 13085-AA010/-AA070/-AA080		



Impreza 1.6 93...11/94 e 1.8 11/92...95, Legacy 1.8 90...91 e 2.2 90...95

Polia da correia sincronizadora

NOVO

SUZUKI

VKM 76001		
Nº original 12810-71C00/C01/C02		



Baleno 95...99, Swift 06/89...05/95 e Vitara 07/90...04/96 (1.6 16V)

Tensor da correia sincronizadora

NOVO

VKM 76202		
Nº original 12810-82001/-82002/-82003		



Samurai 1.3 11/88...03/95, Swift 1.0 8V ...02/88 e Vitara 07/88...04/96 (1.6 8V)

Tensor da correia sincronizadora

VKM 4804	Produtos equiv. NYTRON INA
Nº original 88440-35030	2060



Hilux (2.4, 2.8 e 3.0)

Polia do alternador

NOVO

VKM 4805		7779
Nº original 13505-54020 / 13505-54021		



Hilux 2.4D ...08/01 e 2.8D 09/88...02/95

Tensor da correia sincronizadora

NOVO

TOYOTA

VKM 71002		
Nº original 13505-54020		



Hilux 2.8D Motor MWM

Tensor da correia sincronizadora

VKM 71007		7722
Nº original 13505-15050		



Corolla 1.6 16V 06/91...12/00 e 1.8 16V 06/92...04/97

Tensor da correia sincronizadora

NOVO

VKM 81002		
Nº original 13503-54030		



Hilux 2.4D ...08/01 e 2.8D 09/88...02/95

Polia da correia sincronizadora

TROLLER

VKM 4776		7811	F-565352
Nº original BG5T 10B300 AA			



Troller 3.0

Tensor da correia do alternador

NOVO

Polias e tensores de correias

Principais aplicações

TROLLER - Continuação

Produtos equiv.	NYTRON	INA
VKM 4834	1128	
Nº original 9 407 0 380 002 4 / BF9T 19A216 BA		
	Troller 2.8 turbo com ar cond.	
NOVO	Polia da correia do alternador	
VKM 4835	1222	
Nº orig. 9 407 0 381 009 4/BF9T19A216 AA / 92 056 290/MSB 38103		
	Troller 2.8 turbo com ar cond.	
NOVO	Polia da correia do alternador	
VKM 60001 A	1129	
Troller 2.8 Turbo		
	Tensor da correia do alternador	
VKM 60013 A	7819	
Nº original 940703410074		
Troller 2.8 Turbo		
	Tensor da correia do alternador	





VOLVO

VKM 4768	7715	
Nº original 1660001		
	NL 12-360 (94...98) e B12 (94...98)	
NOVO	Tensor da correia do motor	

VW

VKM 11000 H	7782	F-217668.05 F-217668.2C
Nº original 026 109243 / 026 109243 E		
	Van, Apollo, Gol, Parati, Passat, Saveiro, Voyage, Santana, Quantum, VW Passat/Variant Importados (VR6), Logus, Pointer, Golf e Polo (todos motor AP 1.6, 1.8 e 2.0 com 8V)	
Polia da correia sincronizadora		

VW - Continuação

Produtos equiv.	NYTRON	INA
VKM 11008		
Nº original 058 109243 C/E		
	Passat/Variant Import. 1.8/1.8T 05/99...02/01 (correia com 153 dentes)	
NOVO	Tensor da correia sincronizadora	
VKM 11020		
Nº original 051 109243		
	Golf (Importado) 2.0 16V 02/94...07/98	
Polia da correia sincronizadora		
VKM 11021		
Nº original 051 109243 A		
	Gol, Parati e Passat (2.0 16V)	
Tensor da correia sincronizadora		
VKM 11106 L	7737	F-232489
Nº original 030 109243 K		
	Gol e Parati (AT 1.0 8V)	
Tensor da correia sincronizadora		

VKM 11107 L	7736	
Nº original 030 109243 L/M		
	Fox 1.0 8V e 1.6 8V, Crossfox 1.6 8V, Spacefox 1.6 8V, Polo e Golf 1.6 8V ; Kombi 1.4 8V, Gol 1.0/1.6 8V (todos motor Power 8V EA 111)	
NOVO	Tensor da correia sincronizadora	

VKM 11113		F-123814
Nº original 06A 109479 A/C		
	Bora 2.0, Golf A4 Nac. 1.6 (08/99...06/01) e 2.0 (07/01...); Golf Imp. 1.6 e 2.0 (94...)	
Tensor da correia sincronizadora		

Polias e tensores de correias

Principais aplicações

	Produtos equiv.	NYTRON	INA
VKM 1115 Nº original 06B 109243	7713		
	Golf A4 Nacional 1.8 (07/01...); Golf Imp. 1.8 Turbo (...ch CH1J-Y-850 000); New Beetle 1.8 T (10/99... nº 003 000...)		
	Tensor da correia sincronizadora		
VKM 1116 Nº original 06B 109243 B			
	Golf Imp. 1.8 Turbo (CH1J-Y-850 001...)		
NOVO	Tensor da correia sincronizadora		
VKM 11202 Nº original 078 109243 Q/R			
	Passat/Variant Import. (2.8 04/98...) usado em aplicações com regulador		
NOVO	Tensor da correia sincronizadora		
VKM 21004 Nº original 058 109244	7729		
	Passat/Variant Import. 1.8/1.8T 05/99...02/01 (correia com 153 dentes); Gol, Parati e Polo (motores AT 1.0 16V e 1.0 16V Power)		
NOVO	Polia da correia sincronizadora		
VKM 21115 Nº original 06B 109477	7711		
	Golf Nacional e Importado (1.8/1.8T/1.8T 20V 08/97...); New Beetle 1.8 T (10/99... nº 003 000...)		
	Tensor hidráulico da correia sincronizadora		
VKM 21120 H Nº original 036 109244 D	2053	F-23121901	
	Gol Power (motor 1.0 16V)		
NOVO	Polia auxiliar da correia sincronizadora		





VW - Continuação

	Produtos equiv.	NYTRON	INA
VKM 21122 H Nº original 036 109244	2092	F-227244	
	Gol e Parati (motor AT 1.0 16V e AT 1.0 16V turbo)		
	Polia auxiliar da correia sincronizadora		
VKM 21202 Nº original 078 109244 H			
	Passat/Variant Import. (2.8 04/98...) usado em aplicações com regulador		
NOVO	Polia da correia sincronizadora		
VKM 31004 Nº original 028 145278 E	1173	F-214797.6	
	Golf Imp. 1.6 8V, 1.8 8V e 2.0 8V (02/94...07/98); Polo e Polo Classic 1.6 8V e 1.8 8V 96... e Van 1.8V e 1.8 8V 98...		
	Polia da correia de serviço		
VKM 31011 L Nº original 06A 903 315 E		F-235782	
	Bora 01... e New Beetle 99... (2.0 8V EA113), Golf 08/98... (1.6 8V, 1.8 20V e 2.0 8V), Polo 05/02... (2.0 8V), Polo Sedan 11/02... 2.0 8V com AC)		
NOVO	Tensor da correia de serviço		
VKM 31015 L Nº original 030 145299 C/F	7799	F-235786.01	
	Cross Fox, Fox e Space Fox (sem AC 1.0 8V e 1.6 8V total Flex), Golf (motor EA 111 1.6), Polo/Polo Sedan (com DH e sem AC motor 1.0 8V/16V e 1.6 8V/16V EA 111), Gol (motor 1.0 8V EA 111)		
NOVO	Tensor da correia de serviço		
VKM 4760 Nº original 058 109244	7729CS	F-229021.1	
	Passat/Variant Import. 1.8/1.8T 05/99...02/01 (correia com 153 dentes); Gol, Parati e Polo (motores AT 1.0 16V e 1.0 16V Power)		
NOVO	Polia com suporte da correia sincronizadora		





VW - Continuação

Polias e tensores de correias

Principais aplicações

	Produtos equiv.	NYTRON	INA
VKM 4761 Nº original 036 109243 AB	7749	F-231221.1	
 NOVO	Gol, Parati e Polo (motor Power 1.0 16V) Tensor principal da correia sincronizadora		
VKM 4762 Nº original 036 109243 AC	7753		
 NOVO	Gol e Parati (motor 1.0 16V Power) Tensor auxiliar da correia sincronizadora		
VKM 4769 Nº original 2RP 903157	7718		
 NOVO	7-100 e 8-140 94...97, 12-180 e 14-180 99...00 (caminhões); 16-180, 16-210, 17-210 (ônibus) Tensor da correia do alternador		
VKM 4770 Nº original T12 145275	7719		
 NOVO	11-140, 12-140, 14-140 Tensor da correia do alternador		
VKM 4774 Nº original 036 145299	7798		
 NOVO	Gol e Parati (motor 1.0 8V/16V EA 111 com DH) Tensor do alternador		
VKM 4780 Nº original 030 145299 H	7831	F-565360	
 NOVO	Fox, Crossfox, SpaceFox e Polo (motor EA 111 1.0 8V e 1.6 8V com AC) Tensor do alternador		

VW - Continuação

	Produtos equiv.	NYTRON	INA
VKM 4790 Nº original 032 145276	1125		
 NOVO	Polo Classic 02/01... (1.0 e 1.6 16V), Fox e SpaceFox 1.0 e 1.6 (motor EA 111 todos com AC) Polia da correia do alternador		
VKM 4806 Nº original 030 145299 H	1140	F-565353	
 NOVO	Fox, Novo Gol NF, Golf, Polo, SpaceFox (todos com motor EA 111, com AC e DH 1.0 8V / 1.4 16V / 1.6 8V) Polia do alternador		
VKM 4817 Nº original 032 145299 A	7806		
 NOVO	Golf e Polo (motor 1.6 8V EA 111) Tensor da correia do alternador		
VKM 4823 Nº original 377 260299	1112		
 NOVO	Gol, Parati, Santana, Saveiro (94... motor AP e EA 827 com AC) Polias da correia da dir. hidr. com ar condicionado		
VKM 4824 Nº original 377 145299	1113		
 NOVO	Gol, Parati, Santana, Saveiro (94... motor AP e EA 827 sem AC) Polias da correia da dir. hidr. sem ar condicionado		
VKM 4837 Nº original 032 145299 A / 036 145276	1114		
 NOVO	Golf e Polo (motor 1.6 8V EA 111) Polia da correia do alternador		

VW - Continuação

Principais aplicações

VW - Continuação

Produtos equiv. | NYTRON | INA

VKM 4838 | 1152

Nº original 036 145299



Gol e Parati (motor 1.0 8V/16V EA 111 com DH)

NOVO

Polia do alternador

VKM 4839 | 1160 | F-235786.01

Nº original 030 145299 C/F



CrossFox, Fox e SpaceFox (sem AC 1.0 8V e 1.6 8V total Flex), Polo (motor 1.0 8V/16V e 1.6 8V/16V EA-111), Gol (motor 1.0 8V EA 111)

NOVO

Polia da correia de serviço

VKM 60003 L | 7743 | F-551221

Nº original 036 109243 J



Gol, Parati e Polo/Polo Sedan (AT 1.0 16V)

Tensor da correia sincronizadora

VKM 60008 L | 7801

Nº original 377 260229



Gol, Parati, Santana, Saveiro (94... motor AP e EA 827 com AC)

Tensor da correia da dir. hidr. com ar condicionado

VKM 60009 L | 7802

Nº original 377 145299



Gol, Parati, Santana, Saveiro (94... motor AP e EA 827 sem AC)

Tensor da correia da dir. hidr. sem ar condicionado



Produtos Automotivos SKF

...ou você pensa que temos somente os melhores rolamentos?



A SKF disponibiliza ao mercado de reposição uma ampla linha de produtos que você já conhece e confia.

Visite seu distribuidor SKF mais próximo e solicite os já tradicionais Rolamentos Automotivos, Cruzetas, Atuadores Hidráulicos e Mancais de Embreagens, Bombas D'água, Polias e Tensionadores de Correias, Kits de Rolamentos de Rodas, Componentes de Direção e Suspensão, além do mais recente lançamento: - Kits de Reparo para Juntas Homocinéticas - que já encontram-se disponíveis para sua maior tranquilidade e segurança.

SKF. Só quem é líder mundial pode oferecer ao mercado de reposição, uma linha de produtos tão completa.