

Rolamentos para automóveis e utilitários

2008



Índice geral de produtos

Montadora	Rolamentos e kits de roda	Aplicações diversas	Montadora	Rolamento e kits de roda	Aplicações diversas
Alfa Romeo	Pág. 8	Pág. 28	Lada	Pág. 18	Pág. 44 e 45
Asia	Pág. 8	Pág. 28	Land Rover	Pág. 18	
Audi	Pág. 8	Pág. 28	Mazda	Pág. 19	Pág. 45
BMW	Pág. 8	Pág. 28	MBB	Pág. 19	Pág. 45
Chrysler	Pág. 8 e 9	Pág. 28	Mitsubishi	Pág. 19	Pág. 45
Citroen	Pág. 9 e 10	Pág. 28 e 29	Nissan	Pág. 19	
Daewoo	Pág. 10		Peugeot	Pág. 20 e 21	Pág. 45 e 46
Fiat	Pág. 10 a 12	Pág. 29 a 32	Renault	Pág. 21 a 23	Pág. 46 e 47
Ford	Pág. 12 a 14	Pág. 32 a 38	Seat	Pág. 23	
GM	Pág. 14 a 17	Pág. 38 a 43	Subaru	Pág. 23	
Honda	Pág. 17		Suzuki	Pág. 23	
Hyundai	Pág. 17		Toyota	Pág. 23	Pág. 47
Iveco-Fiat	Pág. 18		Troller	Pág. 23	
Kia	Pág. 18	Pág. 44	VW	Pág. 24 e 25	Pág. 47 a 51

Produto	Montadora	Pág
11590/11520/Q	Ford	36
	Ford	37
12G-88128 TN9	Ford	13
	Ford	14
14131/14276/Q	Ford	36
	Ford	37
15101/15245	Ford	13
15103 S/ Q + 15243/Q	GM	14
	GM	15
	GM	16
15578/15520	Kia	18
18590/18520/Q	Ford	14
	GM	14
	GM	15
	GM	16
1982 F/1924 A/QVQ519	Ford	36
25577/2/ 25523/2/Q	Ford	34
	Ford	36
	Ford	37
25877/2/ 25821/2/Q	Ford	14
2788/QCL7C + 2720/QCL7C	Toyota	23
30203 J2	Asia	8
	Ford	32
	Ford	33
30205 J2/Q	Asia	8
	Kia	18
	Renault	23
	Ford	32
30207 J2/Q	Ford	33
	Lada	45
	Asia	8
30208 J2/Q	Kia	18
	Nissan	19
30304 J2/Q	Ford	12
	VW	24
30305 J2	VW	24
30306 J2/Q	Kia	44
30307 J2/Q	Kia	44
	Toyota	47
309544 DB	VW	50
309726 DA	Lada	18
	GM	15
309946 AC	GM	16
31306 J2/Q	Toyota	47
31308 J2/QCL7C	Toyota	47
31594/2/31520/2	Ford	34
	Ford	35
	Ford	36
	Ford	37
	GM	38
	GM	39
	GM	42

Produto	Montadora	Pág
31594/2/31520/2	GM Continuação	43
32005 X/QVB015	Asia	8
	Peugeot	21
32006 X/Q	Iveco - Fiat	18
32007 X/Q	Ford	12
	GM	40
	GM	41
	GM	43
	Renault	23
	Iveco - Fiat	18
32008 X/Q	Kia	44
	Lada	18
	Lada	45
	Fiat	29
32009 X/Q	Fiat	30
	Fiat	31
	Fiat	32
	MBB	19
	Renault	47
32010 X/Q	Iveco - Fiat	18
	MBB	45
32010 X/ QCL7CVB026	Peugeot	21
32011 X/ QCL7CVB026	Peugeot	21
32206 J2/Q	Kia	44
	MBB	19
32207 J2/Q	Kia	44
32304 J2/Q	Ford	33
330757 C/Q	Ford	12
	Ford	33
	GM	39
	GM	40
	GM	42
	VW	47
	GM	42
330865 C/QCL7C	GM	42
33205/Q	MBB	19
361895 B	VW	49
368 A/362 A/Q	Ford	13
	Ford	35
	GM	14
	GM	15
	GM	16
	Ford	35
368 A/362 X/Q	GM	38
	GM	39
	GM	41
	GM	16
368/362 A/Q	GM	16
387 A/382 A/Q	Ford	13
	Ford	35
	Ford	36
3982/3920/2/Q	Ford	13
	GM	14
	GM	15
	GM	16

Produto	Montadora	Pág
442882/Q	Peugeot	21
6001	Ford	32
	Ford	33
6001/C3	Iveco - Fiat	49
6001-2RS1/ C3LHT23	GM	39
	GM	42
6003-2RS1/ C3GJN	Ford	33
	Ford	36
	Ford	37
	GM	39
	GM	40
	GM	41
	GM	43
	VW	48
	VW	49
VW	50	
VW	51	
6005-2RS1/ C3HHT22	Fiat	32
6006-2RS1	Citroen	28
	Citroen	29
	Renault	46
	Renault	47
6006-2RS1/C3GJN	Peugeot	46
6006-RS1/C3GJN	Peugeot	46
613441	Lada	44
	Lada	45
615722	Lada	44
61805	Lada	45
6200-2RS1/ C3GJN	Ford	32
	Ford	36
	Ford	37
	Toyota	47
6201	GM	41
6201-2RSH/ C3GJN	Fiat	29
	Fiat	30
	Fiat	31
	Fiat	32
	Ford	34
	Ford	36
	Ford	37
	Ford	38
	GM	39
	GM	40
	GM	41
	GM	42
	GM	43
	Lada	44
	Lada	45
	MBB	45
	Peugeot	46
	VW	48
	VW	49
	VW	50
	VW	51

Índice geral de produtos

Produto	Montadora	Pág	
6202	Ford	36	
	Ford	37	
6202/C2	Ford	34	
6202-2RSR/ C3GJN	GM	41	
	Renault	46	
	Renault	47	
	Toyota	47	
	VW	48	
	VW	49	
	VW	51	
6202-2Z	Toyota	47	
6203	Toyota	47	
6203-2RSR	Renault	47	
6203-2RSR/ C3HT22VT200	Fiat	29	
	Fiat	30	
	Fiat	31	
	Fiat	32	
	Ford	32	
	Ford	33	
	Ford	34	
	Ford	35	
	Ford	36	
	Ford	37	
	Ford	38	
	GM	38	
	GM	39	
	GM	40	
	GM	41	
	GM	42	
	GM	43	
	Renault	46	
	Renault	47	
	Toyota	47	
	VW	48	
	VW	49	
	VW	50	
	VW	51	
	6203-2Z	Toyota	47
	6203-2Z/C3	Toyota	47
	6204 ETN9/C3H	Fiat	30
Fiat		32	
6205	Kia	44	
	Lada	44	
	Lada	45	
	Peugeot	45	
6205-2Z	Toyota	47	
6205-Z	GM	38	
	GM	39	
6206/C3	GM	42	
	Ford	33	
	Ford	36	
	Ford	37	
	VW	25	
6206 NR	GM	40	
6206-2RS1/C3	GM	41	
6206-2Z	GM	42	
6206-2Z	Toyota	47	
6207/C3	VW	24	
6207-ZN/C3	VW	49	
6207-ZN/C3	GM	43	
6207-ZNR	Ford	37	
6208-2RS1	Asia	28	
6209	Lada	44	
6209 N	Lada	44	
6209 NR/C3	Toyota	47	
62201-2RS1/ C3HTVT193	Fiat	29	
	Fiat	29	
	Fiat	30	
	Fiat	31	
62202-2RS1/C3	Fiat	32	
	Fiat	29	
	Fiat	30	
	Fiat	31	

Produto	Montadora	Pág
62202-2RS1/C3 Continuação	Fiat	32
	Lada	45
62205-2RS1	Lada	44
62206-2RS1	Alfa Romeo	28
62208-2RS1/C3	Lada	18
	Fiat	29
62302-2RS1/C3	Fiat	30
	Fiat	31
	Fiat	32
	Ford	37
63/28	Kia	44
63006-2RS1/C4	Fiat	31
63008-2RS1/HT	Fiat	32
6303	Asia	28
6302-2RSR	Chrysler	28
6302-2RS1/C3	Lada	44
	Lada	45
6303-2RSR	Asia	28
6303-2RSR/C3	Ford	34
	Asia	28
6303-2RSR/C3HT	Fiat	32
	Ford	33
	Ford	36
	GM	39
	GM	42
	MBB	45
	VW	49
	VW	50
	GM	43
	6303-2RSR/ C3HT22	GM
6304-2RS1	Asia	28
6304-Z	Kia	44
6305	Lada	44
6305 ETN9/C3	GM	40
	GM	41
6305/C3	GM	40
	VW	49
6306/C3	VW	24
	VW	49
6306 NR	GM	40
	GM	43
	Lada	44
6306 ZNR/C3	Lada	45
	GM	39
6306-2RS1	GM	40
6306-2RS1NR/C3	GM	40
6306-2Z	Toyota	47
6306-ZNR	Kia	44
6307 NR	Ford	34
	Ford	35
6307-2RS1NR	Ford	35
6307-Z	Toyota	47
6308 NR	Ford	34
	Ford	35
	GM	38
	GM	39
	GM	41
	GM	42
6308-2RS1/C5	Toyota	23
	Fiat	29
639058	Fiat	30
	Fiat	31
	Fiat	32
	Lada	44
639114	Lada	44
639154/Q	Lada	45
B 128	Lada	18
BA2B 446047 AAD	Chrysler	28
BA2B 446047 EB	Peugeot	20
BA2B 446762 B	Citroen	9
	Citroen	9
	Citroen	10

Produto	Montadora	Pág
BA2B 446762 B	Peugeot Continuação	20
BA2B 633313 EA	Fiat	10
BA2B 633668 A	Fiat	31
BAF 4104 BBX	Audi	8
	VW	24
BAF 4106 BA	Peugeot	21
BAF-0006 D	Kia	18
BAF-0011	Fiat	11
	Fiat	10
BAF-0013 AD	Fiat	11
	Fiat	12
BAF-0040 B	Fiat	11
BAF-0049 C	VW	24
BAF-0058 B	VW	25
BAF-4039 B	Ford	14
BAF-4040 C	Ford	14
BAF-4106 AE	Citroen	10
BAF-4110 AB	Citroen	9
BAF-4110 BC	Citroen	9
BAFB 444450	Citroen	10
AAB	Peugeot	20
BAFB 446451 EB	Peugeot	20
BAFB 446451 EE	Peugeot	20
BAFB 446930 AE	Ford	12
BAFB 446935 AE	Ford	12
BAFB 447302 BB	Citroen	10
	Peugeot	20
BAFB 447302 BC	Citroen	10
BAFB 447306 AC	Kia	18
BAFB 447312 A	GM	16
BAFB 447318 B	BMW	8
BAFB 447320 BC	Peugeot	20
BAFB 633555	Fiat	12
BAFB 633755 C	Alfa Romeo	8
BAFB 633807 D	Fiat	12
BAFB 633938 B	Fiat	12
BAFB 636009 C	Alfa Romeo	8
BAH-0004 AA	Alfa Romeo	8
	Fiat	11
BAH-0011 D	Audi	8
	VW	25
BAH-0012 AD	Alfa Romeo	8
	Fiat	10
	Fiat	11
BAH-0013 D	Fiat	12
	Fiat	12
BAH-0023	VW	25
	Fiat	10
BAH-0031 D	Fiat	11
	Daewoo	10
BAH-0036	Ford	12
	Ford	13
	Ford	14
	VW	24
	VW	25
BAH-0049 C	Audi	8
	VW	24
BAH-0051 B	Citroen	9
	Citroen	10
	Peugeot	20
BAH-0053 AE	Fiat	11
	Fiat	10
BAH-0055 AA	Fiat	11
	Fiat	12
BAH-0059 C	MBB	19
BAH-0072 D	Citroen	9
BAH-0076 ED	Fiat	11
BAH-0077 D	Fiat	11
BAH 0094	Renault	21
	Renault	22
BAH-0106 D	Ford	12

Índice geral de produtos

Produto	Montadora	Pág
BAH-0106 D Continuação	Ford	13
	Ford	14
BAH-0108 B	Ford	14
	Ford	12
BAH-0109 C	Ford	13
	VW	25
BAH 0168	Citroen	9
	Citroen	10
	Peugeot	20
BAH-0171	Peugeot	21
	Peugeot	20
BAH-5000 A	Peugeot	20
BAH-5001 A	Peugeot	20
BAHB 309797 C	MBB	19
	Ford	14
BAHB 311315 ADB	VW	24
	VW	25
BAHB 311316 B	VW	25
	GM	14
BAHB 311396 AA	GM	15
	GM	16
	GM	17
	GM	17
BAHB 311424 B	BMW	8
	Seat	23
BAHB 311443 B	VW	24
	VW	25
BAHB 633313 EA	Fiat	10
	Lada	18
BAHB 633815 AA	Audi	8
	VW	24
BAHB 633966 BB	Ford	14
BAHB 636060 C	Kia	18
BAHB 636096 A	GM	16
	GM	15
BAHB 636114 B	GM	16
	GM	16
BAHB 636214 A	Audi	8
	GM	15
BAR-0029 D/ VK108	GM	16
	GM	17
	GM	15
BAR-0042 AB	GM	16
	GM	17
	GM	17
BAR-0045 B	GM	15
	GM	17
BAR-0048	GM	15
	GM	17
BAR-0049 E	GM	15
	GM	17
BAR-0050 AC	GM	15
	GM	17
BAR-0053 C	GM	15
	GM	16
	GM	17
BAR-0066 C	GM	15
	GM	17
BARB 636077 B/VC463	GM	14
BARB 636078 C	Ford	14
	Fiat	29
BB1-0016 A	Fiat	30
	Fiat	31
	Fiat	32
	Fiat	32
BB1-0078	Ford	33
	Ford	36
BB1-3065 C	Ford	33
	Ford	36
	GM	39
	GM	40
	GM	41
	GM	42
	GM	43
	VW	48

Produto	Montadora	Pág
BB1-3065 C Continuação	VW	49
	VW	50
BB1B 362021	Ford	37
	Fiat	29
	Fiat	31
	Fiat	32
BB1B 362668 A	Fiat	34
	Ford	33
	Ford	34
	Lada	45
BB1B 362711 A	Ford	33
	Ford	34
	Ford	36
BB1B 362937 B	Ford	34
	Ford	36
BB1B 630857	Fiat	32
	Fiat	29
BB1B 631046 B	Fiat	30
	Fiat	31
	Fiat	32
	Fiat	29
BC1B 635251	Fiat	31
	Fiat	30
BCAB 326332 B	Fiat	31
	Ford	38
BD1B 1820100 A	VW	48
	VW	49
	VW	50
	VW	51
	Ford	34
BD1B 1820200 A	VW	48
	GM	40
BK 4020	GM	41
	Ford	33
BT1-0017 A/Q	Ford	36
	Ford	37
BT1-0044 B/QCL7C	Ford	12
	GM	15
BT1B 1870830/Q	Ford	34
	VW	49
BT1B 328236 A/ QCL7VC027	VW	50
	Ford	34
	VW	49
BT1B 328612 C/ QCL7C	VW	50
	Ford	13
	VW	24
BT1B 329013 A/Q	VW	25
	Ford	12
	Ford	13
BT1B 332541 AB/Q	Ford	14
	VW	24
	Citroen	9
BT2B 445539 CC	Citroen	10
	Peugeot	20
	Renault	21
	Renault	22
	Renault	23
BT2B 445620 BB	Renault	21
	Renault	23
BTH 1011 AB	Iveco - Fiat	18
	Peugeot	21
BTH-1024 C	Iveco - Fiat	18
	Ford	12
BTH-1206 AB	Ford	13
	Ford	14
	Peugeot	20
	Citroen	9
BTH-1209 E	Citroen	9
BTHB 1861887 AA	Iveco - Fiat	18
CRA.BR 10	Chrysler	8
CRA.BR 930014	Chrysler	8
CRA.BR 930066	Chrysler	8
CRA.BR 930067	Chrysler	8
CRA.BR 930069	Chrysler	8

Produto	Montadora	Pág
CRA.BR 930138	Chrysler	9
CRA.BR 930176	Chrysler	9
CRA.BR 930182 K	Chrysler	9
CRA.BR 930194	Chrysler	9
CRA.BR 930195	Chrysler	9
CRA.BR 930196	Chrysler	9
CRA.BR 930206	Chrysler	9
CRA.BR 930215	Chrysler	8
CRA.BR 930216	Chrysler	8
CRA.BR 930219	Chrysler	8
CRA.BR 930335	Chrysler	8
CRA.FW 169	Chrysler	9
CRA.R 1559-TV	Chrysler	8
CRA.R 1563-TAV	Chrysler	8
HK 1712	GM	40
HK 2526	MBB	45
	Ford	35
HM 803146/2/ 110/2/QCL7C	Ford	36
	MBB	45
	Ford	35
HM 807046/ 010/QCL7C	GM	38
	GM	39
	GM	42
	Ford	35
HM 88542/2/ 510/2/QCL7C	Ford	36
	Ford	38
	Chrysler	28
HM 88649/2/ 610/2/QCL7C	Ford	35
	Ford	37
	GM	40
HM 88649/2/ 620/2/QCL7C	Ford	34
	Ford	38
HM 89449/2/ 410/2/QCL7C	GM	42
	Mitsubishi	45
JL 69349 X/310/Q	Peugeot	45
	Chrysler	9
JL 69349/310/Q	Kia	18
	GM	38
	GM	42
	GM	43
	Toyota	23
JLM 104948 AA/ 910AA/Q	Troller	23
	Lada	45
K 32x37x27	Audi	8
	Daewoo	10
	Ford	12
	Ford	14
	Ford	33
	Ford	34
	GM	15
	GM	16
	Seat	23
	VW	24
	VW	25
	VW	47
	VW	49
	VW	50
L 68149/111/Q	MBB	19
LM 102949/910/Q	Kia	18
	Mitsubishi	19
	Toyota	23
	Troller	23
LM 104949/911/Q	Ford	13
	Daewoo	10
	Ford	12
	Ford	14
LM 11749/710/ QVC027	GM	15
	GM	16
	Seat	23
	VW	24
	VW	25
LM 11949/910/Q	Audi	8

Índice geral de produtos

Produto	Montadora	Pág	Produto	Montadora	Pág	Produto	Montadora	Pág
LM 11949/910/Q Continuação	Ford	12	M 802048/011/ QCL7C Continuação	GM	39	VKBA 1481	Ford	14
	Ford	13		GM	41	VKBA 1482	Ford	14
	Ford	14		GM	42	VKBA 1483	Ford	14
	GM	15		GM	43	VKBA 1484	Ford	14
	GM	42		M 84548/2/510/ 2/QVQ506	GM	40	VKBA 1488	Alfa Romeo
	Lada	18	GM	41	VKBA 1491	Fiat	11	
	VW	24	M 86647/610/ QCL7C	GM	40	VKBA 1494	VW	25
VW	25	M 86649/2/610/ 2/QVQ506	GM	43	VKBA 1498	Renault	22	
LM 12749/710/Q	Ford	13	GM	50	VKBA 1915	MBB	19	
LM 12749/711/Q	MBB	19	VW	34	VKBA 1948	Mitsubishi	19	
	Chrysler	9	Ford	35	VKBA 1950	Mazda	19	
LM 29749/710/Q	Ford	33	Ford	37	VKBA 1951	Kia	18	
	Ford	34	Ford	38	VKBA 1951	Toyota	23	
	VW	47	GM	38	VKBA 1956	Mitsubishi	19	
	VW	49	GM	39	VKBA 1992	Hyundai	17	
	VW	50	GM	40	VKBA 3219	Suzuki	23	
LM 29749 F/711/Q	Ford	33	GM	41	VKBA 3220	Suzuki	23	
	Ford	34	GM	42	VKBA 3225	Renault	22	
	Ford	36	N 4093	Chrysler	28	VKBA 3229	Mazda	19
	GM	40	N 4122	Chrysler	28	VKBA 3235	Subaru	23
LM 300849/811/Q	GM	41	N 4166	Chrysler	28	VKBA 3236	Subaru	23
	Ford	12	NJ 205 ECP/C3	Lada	45	VKBA 3245	Honda	17
	Ford	33	NU 206 ECP/C3	VW	25	VKBA 3246	Honda	17
	Ford	38	NU 2205 ECP	Renault	46	VKBA 3250	Honda	17
	VW	48	U 399/360 A/L	GM	15	VKBA 3251	Honda	17
	VW	49		GM	16	VKBA 3255	Daewoo	10
	VW	50		Hyundai	17	VKBA 3257	Daewoo	10
Asia	8	Kia		18	VKBA 3266	Hyundai	17	
LM 48548/510/Q	Ford	13	U 399/365 A/L	Ford	13	VKBA 3267	Hyundai	17
	Ford	14		Ford	14	VKBA 3279	Kia	18
	GM	14	VKBA 1301	GM	16	VKBA 3280	Kia	18
	GM	15	VKBA 1303	Fiat	12	VKBA 3284	Kia	18
	GM	16	VKBA 1306	Lada	18	VKBA 3285	Kia	18
	Hyundai	17	VKBA 1307	Lada	18	VKBA 3299	Honda	17
	Kia	18	VKBA 1312	Peugeot	21	VKBA 3305	Mitsubishi	19
	Mitsubishi	19	VKBA 1324	Lada	18	VKBA 3306	Mitsubishi	19
	Nissan	19	VKBA 1325	Lada	18	VKBA 3307	Mitsubishi	19
	Chrysler	28	VKBA 1327	Peugeot	20	VKBA 3309	Mitsubishi	19
LM 501349/310/Q	Ford	13	VKBA 1331	Peugeot	20	VKBA 3403	GM	15
	GM	14	VKBA 1355	Audi	8	GM	16	
	GM	16	VKBA 1356	VW	24	GM	15	
	MBB	19	VKBA 1358	Audi	8	VKBA 3409	GM	16
LM 501349/310 Q/2/Q	GM	15	VKBA 1366	VW	25	GM	17	
LM 501349/314/Q	Ford	13	VKBA 1369	Seat	23	VKBA 3410	GM	16
	Ford	34	VKBA 1379	VW	24	VKBA 3420	Land Rover	18
	Ford	37	VKBA 1403	VW	25	VKBA 3422	GM	15
	Ford	38	VKBA 1414	Hyundai	17	GM	16	
	GM	40	VKBA 1432	Hyundai	17	GM	17	
LM 503349A/ 310/ACL7C	MBB	19	VKBA 1369	Mitsubishi	19	VKBA 3427	Audi	8
LM 603049/011/Q	Ford	13	VKBA 1379	Honda	17	VKBA 3428	Peugeot	21
	Land Rover	18	VKBA 1403	Alfa Romeo	8	VKBA 3429	Iveco - Fiat	18
	Nissan	19	VKBA 1414	Fiat	10	Peugeot	21	
LM 603049/012	Chrysler	28	VKBA 1432	Ford	12	VKBA 3430	Peugeot	21
	Ford	37		Ford	13	VKBA 3434	MBB	19
	GM	43		VW	24	VKBA 3435	MBB	19
LM 67048/010/Q	VW	25	VKBA 1438	VW	25	VKBA 3436	Alfa Romeo	8
	Ford	13	VKBA 1439	Fiat	12	VKBA 3454	Peugeot	21
	Ford	14	VKBA 1440	Fiat	10	VKBA 3455	Audi	8
	GM	15	VKBA 1441	Fiat	11	VKBA 3456	VW	24
	GM	16	VKBA 1444	Fiat	12	VKBA 3464	Renault	22
LM 806649/610/Q	VW	24	VKBA 1444	Fiat	12	VKBA 3465	Citroen	10
M 12649/610/Q	MBB	45	VKBA 1441	Fiat	12	VKBA 3468	Peugeot	20
	GM	14	VKBA 1444	Iveco - Fiat	18	Renault	22	
	GM	15	VKBA 1450	Peugeot	21	VKBA 3469	Renault	22
	GM	16	VKBA 1458	Alfa Romeo	8	VKBA 3476	Peugeot	20
	Hyundai	17	VKBA 1460	Alfa Romeo	8	Citroen	9	
M 802048/011/ QCL7C	Mitsubishi	19	VKBA 1475	BMW	8	Citroen	10	
	Ford	34	VKBA 1476	BMW	8	Peugeot	21	
	Ford	35	VKBA 1480	Citroen	10	VKBA 3478	Citroen	10
	Ford	37	VKBA 1475	Peugeot	20	VKBA 3479	Citroen	10
GM	38	VKBA 1476	Fiat	12	VKBA 3482	Citroen	9	
			VKBA 1480	Ford	14			

































Índice geral de produtos

Produto	Montadora	Pág
VKBA 3482 Continuação	Citroen	10
	Peugeot	21
VKBA 3489	Audi	8
	VW	25
VKBA 3491	Renault	23
VKBA 3492	Renault	21
VKBA 3495	Renault	22
VKBA 3496	Renault	21
	Renault	23
VKBA 3506	Renault	21
VKBA 3510	GM	15
	GM	17
VKBA 3511	GM	15
	GM	17
VKBA 3512	GM	15
	GM	16
	GM	17
VKBA 3513	GM	15
	GM	17
VKBA 3514	GM	15
	GM	17
VKBA 3520	MBB	19
VKBA 3521	MBB	19
	Renault	21
	Renault	22
VKBA 3525	Renault	22
	Renault	23
	Renault	23
VKBA 3530	Ford	14
	Ford	13
VKBA 3531	Ford	14
	Ford	13
VKBA 3532	Ford	14
	Ford	14
VKBA 3539	Fiat	10
	Fiat	11
	Fiat	12
VKBA 3542	Renault	22
VKBA 3545	Citroen	9
	Peugeot	20
VKBA 3546	Citroen	9
VKBA 3548	VW	25
VKBA 3551	Iveco - Fiat	18
VKBA 3552	Iveco - Fiat	18
VKBA 3554	Citroen	9
	Citroen	10
	Peugeot	20
	GM	15
VKBA 3555	GM	16
	GM	17
	Peugeot	20
VKBA 3557	Peugeot	20
VKBA 3561	Renault	22
	VW	24
VKBA 3567	VW	25
	Peugeot	20
VKBA 3584	Peugeot	20
VKBA 3587	Citroen	9
VKBA 3596	Renault	21
	Renault	22
VKBA 3600	GM	15
	GM	16
VKBA 3601	GM	15
VKBA 3613	Renault	22
VKBA 3614	Renault	22
VKBA 3637	Renault	22
VKBA 3639	Renault	22
VKBA 3640	Iveco - Fiat	18
	Peugeot	21

Produto	Montadora	Pág
VKBA 3641	Peugeot	21
VKBA 3642	Iveco - Fiat	18
	Peugeot	21
VKBA 3657	Citroen	9
VKBA 3658	Citroen	9
VKBA 3659	Citroen	9
VKBA 3662	Iveco - Fiat	18
VKBA 3664	Iveco - Fiat	18
	Citroen	9
VKBA 3680	Peugeot	20
	Hyundai	17
VKBA 3729	Toyota	23
VKBA 3730	Toyota	23
VKBA 3731	Toyota	23
VKBA 3740	Toyota	23
VKBA 3748	Honda	17
VKBA 3775	Mitsubishi	19
VKBA 3782	Honda	17
	Ford	14
VKBA 4500	VW	24
	VW	25
	Ford	14
VKBA 4501	VW	24
	VW	25
	VW	24
VKBA 4505	VW	24
	GM	15
VKBA 4506	Ford	12
	VW	24
VKBA 4528	Ford	14
	Seat	23
	VW	24
VKBA 4529	VW	25
	Ford	13
	VW	24
VKBA 4533	VW	25
	GM	15
	GM	16
VKBA 4544	Fiat	10
	Ford	12
VKBA 4625 A	Ford	13
	VW	24
	GM	15
VKBA 4687	GM	14
	GM	15
VKBA 4701	GM	16
	GM	17
	GM	17
VKBA 4736	GM	15
	GM	16
VKBA 5248	MBB	19
VKBA 540	Peugeot	21
VKBA 542	Audi	8
VKBA 559	Fiat	10
VKBA 577	VW	25
VKBA 603	VW	24
VKBA 6515	Ford	14
VKBA 743	Citroen	10
	Peugeot	20
VKBA 754	GM	16
VKBA 757	MBB	19
VKBA 882	Citroen	9
	Citroen	10
VKBA 906	Citroen	10
	Peugeot	20
VKBA 909	VW	25
VKBA 915	Renault	22
	Citroen	9
	Citroen	10
VKBA 915	Citroen	10
	Peugeot	20

Produto	Montadora	Pág
VKBA 915	Peugeot Continuação	21
VKBA 926	Lada	18
	Citroen	10
VKBA 961	Peugeot	20
VKBA 966	Renault	22
VKBA 968	Renault	22
	Renault	21
VKBA 969	Renault	22
	Renault	22
VKBA 973	Lada	18
VKBA 976	Renault	21
	Renault	22
VKD 35001	Renault	46
VKD 35002	Citroen	29
	Peugeot	46
VKD 35005	GM	42
	MBB	45
VKD 35007	Peugeot	46
VKD 35013	Ford	37
VKD 35016	Fiat	29
VKD 35017	Fiat	29
VKD 35017 T	Peugeot	46
VKD 35021	Audi	28
VKDA 23001	Citroen	28
VKDA 27006	Peugeot	46
VKDA 27009	Renault	46
VKDA 35110	VW	50
VKDA 35113	Audi	28
	VW	48
VKDA 35115	VW	50
VKDA 35223	Alfa Romeo	28
VKDA 35302	Peugeot	45
VKDA 35305	Peugeot	46
VKDA 35306	Citroen	28
	Peugeot	46
VKDA 35307	Citroen	28
	Citroen	29
	Peugeot	46
VKDA 35316 T	Citroen	28
VKDA 35402	Ford	37
VKDA 35407	Ford	36
VKDA 35501	GM	39
VKDA 35503	GM	38
	GM	43
VKDA 35601	Renault	46
VKDA 35607	Renault	46
VKDA 35615	Renault	46
VKDA 88402	Mazda	45
VKDC 35204	Fiat	29
	Fiat	30
VKDC 35505	GM	42
VKDC 35802	BMW	28
	Fiat	30
VKJP 84887	Fiat	31
	Fiat	32
VKJP 84888	Fiat	29
	Fiat	30
	Fiat	31
	Fiat	32

Rolamentos e kits de roda

Veículo	Observações	Designação SKF	Rol.	Componentes	
ALFA ROMEO	164 (2.0 e 3.0 V6)	2.0 TS ...ch. 0014991 com corpo blindado	•	VKBA 1403 ou BAH-0012 AD	
		Demais modelos	•	VKBA 1488 ou BAH-0004 AA	 
		87...92 (Rolamento com cubo)	•	VKBA 1450 ou BAFB 633755 C	
		93...97 (Rolamento com cubo)	•	VKBA 3436 ou BAFB 636009 C	
ASIA	Topic		•	30205 J2/Q LM 48548/510/Q	
			•	30208 J2/Q	
Towner			•	30203 J2 32005 X/QVB015	
			•	6306-2RS1	
AUDI	A3 (1.6/1.8 e 1.8T)		•	VKBA 3455 ou BAH-0049 C	  
		Com ABS e sem ABS (rolamento com cubo)	•	BAF-4104 BBX	
	A4 Avant, Avant Quattro e Quattro	1.8 e 1.8 Turbo	•	VKBA 1355 ou BAHB 633815 AA	
		Somente para 1.8 com 132 Kw	•	VKBA 1356 ou BAH-0011 D	  2 unid.
	2.4 e 2.8	•	VKBA 3427 ou BAHB 636214 A		
	1.8/2.4 e 2.8	•	LM 11949/910/Q L 45449F/410/Q		
A6, Avant, Avant Quattro e Quattro		1.8 (97...00 Transm. Manual)	•	VKBA 1355 ou BAHB 633815 AA	
		1.8 (97...00 Transm. Autom); 2.4/2.8	•	VKBA 1356 ou BAH-0011 D	  2 unid.
		A6/A6 Avant 97...00	•	VKBA 3489	
		A6/A6 Avant 95...96	•	VKBA 542 ou L 45449F/410/Q LM 11949/910/Q	  2 unid.
BMW	325, 328	Rolamento com cubo	•	VKBA 1458 ou BAFB 447318 B	  
			•	VKBA 1460 ou BAHB 311424 B	  
CHRYSLER	Caravan Gran Caravan	96...02 (Roda 15" e 16")	•	CRA.BR 930215	
		96...00 (Roda 14")	•	CRA.BR 930216	
		97...00 (4X4)	•	CRA.BR 930066	
		97...00 (Roda 15" com ABS)	•	CRA.BR 930067	
		97...00 (Roda 14")	•	CRA.BR 930069	
	Cherokee Gran Cherokee	94...98 (4X2) e 90...98 (4X4)	•	CRA.BR 930014	
		Cherokee 00...01 (4X2/4X4)	•	CRA.BR 930219	
		Gran Cherokee 99...02 (4X2/4X4)	•	CRA.BR 930335	
		95...96 (Eixo Spicer 44)	•	CRA.BR 10	
		00...01 8.25" (Ring Gear)	•	CRA.R 1559-TV	
	00...01 (Eixo Spicer 35)	•	CRA.R 1563-TAV		



Rolamentos e kits de roda

Veículo	Observações	Designação SKF	Rol.	Componentes				
CHRYSLER - Continuação	Dakota	LM 12749/711/Q JL 69349/310/Q						
	Neon	95... (Rolamento com cubo - 5 furos)	CRA.BR 930182 K					
		95... (Só rolamento)	CRA.FW 169					
		95...97 (Com ABS rolamento + cubo 4 furos)	CRA.BR 930195					
		95... (Sem ABS rolamento + cubo) 95...97 (Com ABS rolamento + cubo 5 furos)	CRA.BR 930196					
		98... (Com ABS)	CRA.BR 930206					
	Stratus	95... (Com cubo)	CRA.BR 930138					
		1999 (Sem ABS freio a tambor)	CRA.BR 930138					
		95...97 (Com ABS)	CRA.BR 930176					
		95...98 e 2000 (Sem ABS freio a tambor)	CRA.BR 930194					
CITROEN	Berlingo (1.8)	VKBA 915 ou BAH-0171						
		Sem ABS (Rolamento com cubo)	VKBA 3477					
		Com ABS (Rolamento com cubo)	VKBA 3482					
	C3 (1.4 8V e 1.6 16V)	02... (Com ABS)	VKBA 3657 ou BAH-0072 D					
		02... (Sem ABS)	VKBA 3554 ou BAH-0051 B					
		02... (Freio a tambor)	VKBA 3658 ou BT2B 445539 CC					2 unid.
		02... (Freio a disco)	VKBA 3659					
	C4 (2.0 16V)	Rolamento com cubo	VKBA 3587					
			VKBA 3680 ou BTH-1209 E					
	Xsara (1.6/1.8 e 2.0 16V)	02/99... (Sem ABS)	VKBA 3554 ou BAH-0051 B					
		...01/99 (Sem ABS)	VKBA 882 ou BA2B 446762 B					
		Com ABS Freio a disco (Rolamento com cubo)	VKBA 3545 ou BAF-4110 BC					
		Sem ABS Freio a disco (Rolamento com cubo)	VKBA 3546 ou BAF-4110 AB					
Xantia (2.0 8V e 16V)		VKBA 915 ou BA2B 446047 EB						
	Sem ABS 07/95... (Rolamento com cubo)	VKBA 3477						



Rolamentos e kits de roda

Veículo	Observações	Designação SKF	Rol.	Componentes	
CITROEN - Continuação ...Continuação Xantia (2.0 8V e 16V)	Com ABS 07/95... (Rolamento com cubo)	• VKBA 3478 ou BAF-4106 AE			
	Com ABS 93...06/95 (Rolamento com cubo)	• VKBA 3479			
	Sem ABS 93...06/95 (Rolamento com cubo)	• VKBA 743 ou BAFB 444450 AAB			
	Xsara Picasso (1.6 16V e 2.0 16V)	Sem ABS (02/99...)	• VKBA 3554 ou BAH-0051 B		
	Sem ABS (...01/99)	• VKBA 882 ou BA2B 446762 B			
	1.8 e 2.0 16V Sem ABS (Rolamento com cubo)	• VKBA 3477			
	Com ABS (Rolamento com cubo)	• VKBA 3482			
ZX (1.8 8V e 2.0 8V/16V)		• VKBA 915 ou BAH-0171			
	Freio a disco (Rolamento com cubo)	• VKBA 1475 ou BAFB 447302 BB			
	Station Wagon (Rolamento com cubo)	• VKBA 3465 ou BAFB 447302 BC			
	Freio a tambor	• VKBA 961 ou BT2B 445539 CC		3 unid.	
DAEWOO Espero (2.0 8V)	...06/96	• VKBA 3257 ou BAH-0036		2 unid.	
	Sem ABS	• VKBA 3255 ou LM 11749/710/QVC027 L 45449F/410/Q			
FIAT 147, Pick-Up e Spazio	11/85...	• VKBA 1414 ou BAH-0031 D			
	...10/85	• VKBA 559 ou BAHB 633313 EA		2 unid.	
	147, Oggi, Prêmio, Spazio e Uno	Unidade rolamento + cubo	• VKBA 4625 A		
	Brava e Doblò	Sem ABS	• VKBA 1439 ou BAH-0012 AD		
		Com ABS	• VKBA 3539 ou BAH-0055 AA		
		Brava Sem ABS (Rolamento com cubo)	• BAF-0013 AD		
	Elba, Oggi, Prêmio e Uno	Todos 11/85...	• VKBA 1414 ou BAH-0031 D		
		...10/85	• VKBA 559 ou BA2B 633313 EA		2 unid.
	Fiorino	10/85 ...94	• VKBA 1414 ou BAH-0031 D		
		94...	• BAH-0012 AD		
Idea (1.4 8V ELX e 1.8 8V HLX)	Sem ABS (1.8 8V HLX)	• BAH-0012 AD			
	Com ABS (1.8 8V HLX)	• BAH-0055 AA			
	Sem ABS (1.4 8V ELX)	• BAH-0031 D			



Rolamentos e kits de roda

Veículo	Observações	Designação SKF	Rol.	Componentes
...Continuação Idea (1.4 8V ELX e 1.8 8V HLX)	Sem ABS (Rolamento com cubo)	VKBA 4625 A		
	Com ABS (Rolamento com cubo)	BAF-0011		
Marea, Marea Turbo, Marea Weekend	Sem ABS 1.8 16V	VKBA 1439 ou BAH-0012 AD		
	2.0 e 2.4 16V/20V	VKBA 1488 ou BAH-0004 AA		
	Com ABS 1.8 16V	VKBA 3539 ou BAH-0055 AA		
	Com ABS 1999 2.0 16V/20V (Rolamento com cubo)	BAF-0011		
	1.8 16V (SX) e 2.0 16V/20V (Rolamento com cubo)	BAF-0013 AD		
Palio, Palio Weekend, Palio Weekend Adventure e Siena	03... 1.8 8V Sem ABS	BAH-0012 AD		
	1.8 8V 03...; Palio/Palio Weekend 1.6 2000 (todos com ABS)	VKBA 3539 ou BAH-0055 AA		
	Sem ABS inclusive Adventure	BAH-0031 D		
	Com ABS exceto Adventure (Rolamento com cubo)	BAF-0011		
	...12/02 Sem ABS exceto Adventure (Rolamento com cubo)	BAF-0013 AD		
	03... Sem ABS (Rolamento com cubo)	VKBA 4625 A		
Punto Linea	Sem ABS (1.8 8V)	BAH-0012 AD		
	Com ABS (1.8 8V)	BAH-0055 AA		
	Sem ABS (1.4 8V Fire)	BAH-0013 D		
	Com ABS (1.4 8V Fire)	BAH-0053 AE		
	Sem ABS (1.4 8V Fire e 1.8 8V)	BAF-0013 AD		
	Com ABS (1.4 8V Fire e 1.8 8V)	BAF-0040 B		
Stilo	Sem ABS	BAH-0076 ED		
	Com ABS	BAH-0077 D		
	Sem ABS (Rolamento com cubo)	BAF-0013 AD		
	Sem ABS (Rolamento com cubo)	VKBA 1440		
	Com ABS (Rolamento com cubo)	BAF-0040 B		
Strada	Sem ABS	VKBA 1439 ou BAH-0012 AD		
	Com ABS 03... Exceto Working 1.5	VKBA 3539 ou BAH-0055 AA		

FIAT - Continuação













































Rolamentos e kits de roda

Veículo	Observações	Designação SKF	Rol.	Componentes			
FIAT - Continuação	Tempra e Tempra SW	Sem ABS	•	VKBA 1439 ou BAH-0012 AD			
		Com ABS	•	VKBA 3539 ou BAH-0055 AA			
		Sem ABS Disco (Rolamento com cubo)	•	VKBA 1303 ou BAFB 633555			
		Com ABS 16V e Turbo (Rolamento com cubo)	•	VKBA 1476 ou BAFB 633938 B			
		Sem ABS Freio a tambor rolamento com cubo (Tempra SW)	•	BAF-0013 AD			
FIAT - Continuação	Tipo	1.6	•	VKBA 1438 ou BAH-0013 D			
		2.0	•	VKBA 1439 ou BAH-0012 AD			
		1.6 (Rolamento com cubo)	•	VKBA 1440 ou BAF-0013 AD			
		2.0 Sem ABS Opcional BAF-0011 (Rolamento com cubo)	•	VKBA 1441 ou BAFB 633807 D			
		2.0 Sem ABS Tambor (Rolamento com cubo)	•	BAF-0013 AD			
FIAT - Continuação	Belina I ...78 e Corcel I ...78	...04/70	•	32007 X/Q			
		05/70...	•	330757 C/Q			
			•	30304 J2/Q BT1B 1870830/Q			
FIAT - Continuação	Belina II 79..., Corcel II 79..., Del Rey, Pampa e Scala		•	330757 C/Q			
			•	LM 11949/910/Q BT1B 1870830/Q			
		Pampa 4X4	•	LM 300849/811/Q			
FIAT - Continuação	Courier		•	VKBA 1432 ou BAH-0036			
		Sem ABS rolamento com cubo	•	BAFB 446930 AE			
		Com ABS rolamento com cubo	•	BAFB 446935 AE			
FIAT - Continuação	EcoSport	Com ABS (4X2 e 4X4)	•	BAH-0106 D			
		Sem ABS (4X2 e 4X4)	•	BAH-0109 C			
		Com ABS (4X4)	•	BAH-0106 D			
		Sem ABS (4X4)	•	BAH-0109 C			
		Com e sem ABS (4X2)	•	BTH-1206 AB			
FIAT - Continuação	Escort e Verona	...93	•	VKBA 4687 ou BT1B 332541 AB/Q			
		...93	•	VKBA 4528 ou LM 11749/710/QVC027 L 45449F/410/Q			



Rolamentos e kits de roda

Veículo	Observações	Designação SKF	Rol.	Componentes
...Continuação Escort e Verona	94... Exceto Escort Hobby	VKBA 1432 ou BAH-0036		  
	94...	VKBA 4533 ou BT1B 329013 A/Q		   
	Escort Hobby	VKBA 4687 ou BT1B 332541 AB/Q		   
Explorer	...95 (4X2)	LM 11949/910/Q LM 67048/010/Q		
	95... (4X2)	LM 12749/710/Q LM 48548/510/Q		
	...95 (4X4)	LM 603049/011/Q		
	Todos	U 399/365 A/L		
F-100	...83	LM 11949/910/Q LM 48548/510/Q		
	...86	12G-88128 TN9		
F-350 e F-400	...77	15101/15245 LM 501349/310/Q		
		368 A/362 A/Q 387 A/382 A/Q		
F-1000	Eixo Albarus 46	LM 11949/910/Q LM 48548/510/Q		
	Eixo Albarus 46 (4X2 90... e 4X4 93...)	LM 501349/314/Q LM 603049/011/Q		
	Eixo Albarus modelo 44-1	U 399/365 A/L		
F-2000 e F-4000	...85	15101/15245 LM 501349/310/Q		
	F-2000	LM 104949/911/Q		
	F-4000 com eixo Albarus M70 HD	368 A/362 A/Q 3982/3920/2/Q		
Fiesta e Ka	Exceto Novo Fiesta 02...	VKBA 1432 ou BAH-0036		  
	Exceto Novo Fiesta 02...	VKBA 4533 ou BT1B 329013 A/Q		   
Novo Fiesta 02... Novo Ka 08...	Com ABS Exceto Fiesta street	BAH-0106 D		
	Sem ABS Exceto Fiesta street	BAH-0109 C		
	Com ou sem ABS Exceto Novo Ka	BTH-1206 AB		
	Novo Ka	VKBA 4533 ou BT1B 329013 A/Q		   
Focus	Sem ABS	BAH-0109 C		
	Com ABS	VKBA 3531 ou BAH-0106 D		
	Com ou sem ABS	VKBA 3532 ou BTH-1206 AB		  

FORD - Continuação



Rolamentos e kits de roda



































Veículo	Observações	Designação SKF	Rol.	Componentes
Fusion	Sem ABS	VKBA 3530 ou BAH-0108 B		
	Com ABS	VKBA 3531 ou BAH-0106 D		
	Com ABS	VKBA 3532 ou BTH-1206 AB		
	Sem ABS	VKBA 6515		
Jeep Willys, Rural Willys e F-75 (4X4)	60...83	18590/18520/Q		
	08/68...	12G-88128 TN9		
	60...66	25877/2/25821/2/Q		
Mondeo 93...		VKBA 1480 ou BAHB 633966 BB		
	Rolamento com cubo 4X4 (Perua)	VKBA 1483 ou BARB 636077 B/VC463		
	Rolamento com cubo	VKBA 1481 ou BAF-4039 B		
	Com ABS rolamento com cubo	VKBA 1482 ou BAF-4040 C		
	Perua rolamento com cubo	VKBA 1484 ou BARB 636078 C		
Ranger	...95 (4X2)	LM 11949/910/Q LM 67048/010/Q		
	95... (4X2)	LM 11949/910/Q LM 48548/510/Q		
	2.3/4.0	U 399/365 A/L		
Sierra L, XR3 e S		BT1B 332541 AB/Q		
		BT1B 332541 AB/Q		
Versailles e Versailles Royale 1.8 e 2.0	...03/94	VKBA 4500 ou BAHB 311315 ADB		
	04/94...	VKBA 4501 ou BAH-0036		
		VKBA 4529 LM 11749/710/QVC027 L 45449F/410/Q		
A 10	4X4	M 12649/610/Q LM 48548/510/Q		
A 20/Bonanza/Veraneio	4X4	18590/18520/Q		
		M 12649/610/Q LM 48548/510/Q		
A 40		15103 S/Q + 15243/Q LM 501349/310/Q		
	85...	368 A/362 A/Q 3982/3920/2/Q		
Astra (1.8 e 2.0)	...98	VKBA 4736 ou BAHB 311396 AA		

FORD - Continuação

GM



Rolamentos e kits de roda

Veículo	Observações	Designação SKF	Rol.	Componentes
...Continuação Astra (1.8 e 2.0)	99... 8V Freio a disco 4 furos (Rolamento com cubo)	VKBA 3510 ou BAR-0048		
	99... 8V Freio a disco ABS 4 furos (Rolamento com cubo)	VKBA 3511 ou BAR-0049 E		  
	99...16V Freio a disco 5 furos (Rolamento com cubo)	VKBA 3512 ou BAR-0053 C		
	99...16V Freio ABS 5 furos (rolamento com cubo)	VKBA 3513 ou BAR-0050 AC		
	Freio a disco ABS 4 furos (Rolamento com cubo)	VKBA 3409 ou BAR-0045 B		
	Freio a disco e tambor 4 furos (rolamento com cubo)	VKBA 3422 ou BAR-0029 D/VK108		 4 unid.
	2.0 99...Freio a disco 5 furos (rolamento com cubo)	VKBA 3514 ou BAR-0066 C		
	2.0 99...Freio ABS 5 furos (rolamento com cubo)	VKBA 3555 ou BAR-0042 AB		
Blazer/Gran Blazer (2.2/2.4/2.5/2.8 turbo diesel e 4.3)	4X2	M 12649/610/Q LM 67048/010/Q		
	Somente Blazer 97...	U 399/360 A/L		
C 10		M 12649/610/Q LM 48548/510/Q		
C 20	4X4	18590/18520/Q		
		M 12649/610/Q LM 48548/510/Q		
C 40		15103 S/Q + 15243/Q LM 501349/310/Q/2/Q		
	85...	368 A/362 A/Q 3982/3920/2/Q		
Calibra (2.0 e 2.2)		VKBA 4736 ou BAHB 311396 AA		 
		309946 AC		
Caravan e Opala (2.5 e 4.1)	...75	LM 11749/710/QVC027 BT1B 1870830/Q		
	75...	VKBA 4701 LM 11949/910/Q LM 67048/010/Q		 
Celta (1.0 e 1.4)		VKBA 3403 ou BAHB 636114 B		  2 unid.
		VKBA 4544 ou LM 11749/710/QVC027 L 45449F/410/Q		  
Chevette, Chevy 500 e Marajó (1.0/1.4 e 1.6)		VKBA 4506 ou LM 11749/710/QVC027 BT1B 1870830/Q		 
Corsa Hatch, Pick-Up, Sedan		VKBA 3403 ou BAHB 636114 B		  2 unid.
		VKBA 4544 ou LM 11749/710/QVC027 L 45449F/410/Q		  
	02...	VKBA 3600		   2 unid.
	02...	VKBA 3601		  

GM - Continuação



Arruela



Porca



Anel trava



Anel elástico



Retentor



O-ring



Anel de junta



Cupilha



Calota



Graxa



























Rolamentos e kits de roda

Veículo	Observações	Designação SKF	Rol.	Componentes
D 10		M 12649/610/Q LM 48548/510/Q		
D 20 (Bonanza/Veraneio)	4X4	18590/18520/Q		
		M 12649/610/Q LM 48548/510/Q		
D 40		15103 S/Q + 15243/Q LM 501349/310/Q		
	85...	368 A/362 A/Q 3982/3920/2/Q		
Ipanema, Kadett, Monza (1.8 e 2.0)		VKBA 4736 ou BAHB 311396 AA		2 unid.
		VKBA 4544 ou LM 11749/710/QVC027 L 45449F/410/Q		
Meriva (1.8 8V/16V) e Montana (1.4/1.8 8V)	Sem ABS	VKBA 3600		
	Sem ABS (Rolamento com cubo)	VKBA 3422		
Prisma (1.4)		VKBA 3403 ou BAHB 636114 B		2 unid.
		VKBA 4544 ou LM 11749/710/QVC027 L 45449F/410/Q		
Omega e Omega Suprema (2.0/2.2/3.0 e 4.1)	93...98 Com ABS (Rolamento com cubo)	VKBA 1301 ou BAFB 447312 A		
	2.0 e 2.2	VKBA 754 ou BAHB 311396 AA		
	3.0 e 4.1	309946 AC		
S10 (2.2/2.4/2.5 e 2.8 Turbo diesel e 4.3)	4X2	M 12649/610/Q LM 67048/010/Q		
	97...	U 399/360 A/L		
Silverado		M 12649/610/Q LM 67048/010/Q		
		368/362 A/Q 3982/3920/2/Q		
Tigra (1.4 e 1.6)		VKBA 3403 ou BAHB 636114 B		4 unid.
		VKBA 4544 ou L 45449F/410/Q LM 11749/710/QVC027		
Vectra (2.0/2.2 e 2.4)	94....96	VKBA 4736 ou BAHB 311396 AA		
	97....	VKBA 3410 ou BAHB 636096 A		
	8V Com ABS (Rolamento com cubo)	VKBA 3409 ou BAR-0045 B		
	8V Sem ABS (Rolamento com cubo)	VKBA 3422 ou BAR-0029 D/VK108		
	Com ABS 5 furos (03/95... 2.0/2.2 1.6V e 06... 2.0/2.4) rolamento com cubo	VKBA 3555 ou BAR-0042 AB		
	Sem ABS 5 furos (06... 2.0/2.4) rolamento com cubo	VKBA 3512 ou BAR-0053 C		

GM - Continuação



Rolamentos e kits de roda

Veículo	Observações	Designação SKF	Rol.	Componentes	
GM - Continuação	...Continuação Vectra (2.0/2.2 e 2.4)	Com ABS 5 furos (06... 2.0/2.4) rolamento com cubo	•	VKBA 3513 ou BAR-0050 AC	 
		Sem ABS 5 furos (06... 2.0/2.4) rolamento com cubo	•	VKBA 3514 ou BAR-0066 C	
	Zafira (2.0)	...98	•	VKBA 4736 ou BAHB 311396 AA	 2 unid. 
		99...8V Freio a disco 4 furos (Rolamento com cubo)	•	VKBA 3510 ou BAR-0048	
		99...8V Freio ABS 4 furos (Rolamento com cubo)	•	VKBA 3511 ou BAR-0049 E	
		99...16V Freio a disco 5 furos (Rolamento com cubo)	•	VKBA 3512 ou BAR-0053 C	  
		99...16V Freio ABS 5 furos (Rolamento com cubo)	•	VKBA 3513 ou BAR-0050 AC	
		Freio ABS 4 furos (Rolamento com cubo)	•	VKBA 3409 ou BAR-0045 B	
		Freio a disco e tambor 4 furos (Rolamento com cubo)	•	VKBA 3422 ou BAR-0029 D/VK108	
	99...Freio a disco 5 furos (Rolamento com cubo)	•	VKBA 3514 ou BAR-0066 C		
	99...Freio ABS 5 furos (Rolamento com cubo)	•	VKBA 3555 ou BAR-0042 AB		
HONDA	Accord (2.2 e 2.3)	...97 4 furos (Rolamento com cubo)	•	VKBA 3250	
		Freio a tambor ...93 (Rolamento com cubo)	•	VKBA 3251	
		4X2 ...93 Freio a disco com ABS (Rolamento com cubo)	•	VKBA 3299	
		Tração 4x4 ...93 Freio a disco com ABS (Rolamento com cubo)	•	VKBA 3748	
Civic	Sem ABS 1.6 16V ...12/95	•	VKBA 3245		
	Com ABS (1.6 16V ...96, 1.7 02/01... e 2.0 sport 97...)	•	VKBA 3246	  	
	Sem ABS freio a disco (1.6 16V EF3, motor ZC) rolamento com cubo	•	VKBA 3782		
	Sem ABS freio a tambor (Rolamento com cubo)	•	VKBA 1379		
Accent (1.5)		•	VKBA 1366	 2 unid. 	
	Sem ABS	•	VKBA 3266		
	Com ABS (Rolamento com cubo)	•	VKBA 3267		
Excel (1.5)		•	VKBA 1366	 2 unid. 	
		•	VKBA 1992	 	
H 100		•	VKBA 1369 ou LM 48548/510/Q M 12649/610/Q		
		•	VKBA 3712		
		•	U 399/360 A/L	 	











































































Rolamentos e kits de roda

Veículo	Observações	Designação SKF	Rol.	Componentes	
IVECO - FIAT	Daily Diesel e Turbo Daily	Daily II 35s10; 35s11; 35s12; 35s13 Bus; 35s15 05/99...08/03	•	VKBA 3662 ou BTHB 1861887 AA	
		Daily II 35c10; 35s11; 35s12; 35s13; 35s15 05/99...08/03	•	VKBA 3551 ou BTH-1024 C	
		Daily II 35s10; 35s11; 35s12; 35s13 Bus; 35s15 05/99...08/03	•	VKBA 3664	
		Daily II 35c10; 35s11; 35s12; 35s13; 35s15 05/99...08/03	•	VKBA 3552 ou BTH-1011 AB	
IVECO (1.9D, 2.5D e TD, 2.8 D e TD)	...04/02 2 Rolamento para roda	•	VKBA 1444 ou 32010 X/Q	 2 unid.	
	05/02... Freio a disco	•	VKBA 3640	 	
	...04/02	•	VKBA 3429 ou 32006 X/Q 32008 X/Q	 	
	05/02... Freio a disco	•	VKBA 3642	 	
KIA	Besta (2.2/2.7 e GS)	GS	•	15578/15520	
		2.2 e 2.7	•	30205 J2/Q LM 48548/510/Q	
		2.2 e 2.7	•	30208 J2/Q	
		Todos	•	U 399/360 AL	
KIA	Sephia (1.5)	•	VKBA 1950 ou BAHB 636060 C	 	
	Sem ABS (Rolamento com cubo)	•	VKBA 3279 ou BAFB 447306 AC	 	
	Com ABS (Rolamento com cubo)	•	VKBA 3280 ou BAF-0006 D	 	
KIA	Sportage (2.0 e 2.2)	•	VKBA 3284 ou LM 102949/910/Q JL 69349/310/Q	 2 unid.	
		•	VKBA 3285	 2 unid.	
LADA	Laika (1.6)	•	VKBA 926 ou LM 11949/910/Q 639154/Q	 	
		•	VKBA 973	 2 unid.	
	Niva (1.6)	•	VKBA 1324 ou 32008 X/Q	 2 unid.	
		•	VKBA 1325 ou 62208-2RS1/C3	 2 unid.	
LADA	Samara (1.3 e 1.5)	•	VKBA 1306 ou 309726 DA	 	
		•	VKBA 1307 ou BAHB 633313 EA	 	
LAND ROVER	110 Defender	87...98	•	VKBA 3420 ou LM 603049/011/Q	 2 unid.
		87...98	•	VKBA 3420 ou LM 603049/011/Q	 2 unid.
	Discovery	Discovery II ... 05/98 (chassis N° JA032851...)	•	LM 603049/011/Q	 2 unid.















































































Rolamentos e kits de roda

	Veículo	Observações	Designação SKF	Rol.	Componentes
MAZDA	626 (1.8 e 2.0 16V)		VKBA 1948		   
		Sem ABS (Rolamento com cubo)	VKBA 3229		 
MBB	180 C	93...98	VKBA 1498 ou LM 12749/710/Q L 68149/111/Q		 
		93...98	VKBA 757 ou BAHB 309797 C		  
	180 D		32009 X/Q LM 503349A/310/ACL7C		 
			32206 J2/Q LM 503349A/310/ACL7C		 
MITSUBISHI	Classe A (1.6 e 1.9)		VKBA 3520 ou BAH-0059 C		 
			VKBA 3521		  
	Sprinter	Eixo Dana	VKBA 3434 ou 33205/Q LM 501349/310/Q		   
		Dana ...98	VKBA 5248		   
HLO 99...		VKBA 3435		   	
NISSAN	Colt	97... (Rolamento com cubo)	VKBA 3307		 
		97... (Rolamento com cubo)	VKBA 3306		 
	L 200 (2.5 Turbo Diesel)	4X2	VKBA 1369 M 12649/610/Q LM 48548/510/Q		 
		4X4	VKBA 1915 ou LM 102949/910/Q		  
		4X2 e 4X4	VKBA 3775		   
	L 300		VKBA 1915 ou LM 102949/910/Q		  
11/90 ...		VKBA 3775		   	
Lancer (1.6 e 1.8 16V)	Rolamento com cubo	VKBA 3309		   	
	Sem ABS	VKBA 3305		 	
Pajero I (2.5/2.8/3.0 e 3.5)		VKBA 1915 ou LM 102949/910/Q LM 102949/910/Q		  	
		VKBA 1956		   	
NISSAN	Frontier	Nacional e importado	LM 48548/510/Q LM 603049/011/Q		 
		Nacional e importado	30208 J2/Q		 
	X-Terra	Nacional e importado	LM 48548/510/Q LM 603049/011/Q		 
Nacional e importado		30208 J2/Q		 	



Rolamentos e kits de roda

Veículo	Observações	Designação SKF	Rol.	Componentes
106 (1.0/1.4 e 1.6)	Com 3 furos de montagem	VKBA 1327 ou BAH-5001 A		
	Com 4 furos de montagem	VKBA 3554 ou BAH-0051 B		 
	Com 3 furos de montagem	VKBA 3557 ou BAH-5000 A		  
	Com 4 furos de montagem	VKBA 3556 ou BT2B 445539 CC		   2 unid.
205 (1.3/1.4 e 1.6)	Sem ABS	VKBA 882 ou BA2B 446762 B		 
	Com ABS	VKBA 915 ou BAH-0171		  
	Sem ABS	VKBA 961 ou BT2B 445539 CC		   3 unid.
	Com ABS (Rolamento com cubo)	VKBA 1475 ou BAFB 447302 BB		
206 1.0 (Nacional); 1.4; 1.6 (Importado) e 207	Sem ABS	VKBA 3554 ou BAH-0051 B		 
	Com ABS	VKBA 915 ou BAH-0171		  
		VKBA 3556 ou BT2B 445539 CC		   2 unid.
306 (1.6/1.8 e 2.0)	Sem ABS diâmetro do eixo 35 mm	VKBA 882 ou BA2B 446762 B		 
	Sem ABS diâmetro do eixo 42 mm	VKBA 915 ou BAH-0171		  
	Sem ABS diâmetro do eixo 37 mm	VKBA 3554 ou BAH 0051 B		 
	Freio a tambor sem ABS	VKBA 961 ou BT2B 445539 CC		   3 unid.
	01/97...09/98 Freio a disco com ABS (Rolamento com cubo)	VKBA 1475 ou BAFB 447302 BB		
	SW 02/97...09/98 Freio a tambor (Rolamento com cubo)	VKBA 3465 ou BAFB 447320 BC		
	10/98...07/04 Freio a disco (Rolamento com cubo)	VKBA 3545		 
307 (1.6 16V e 2.0 20V)		VKBA 3584 ou BA2B 446047 AAD		 
		VKBA 3680 ou BTH 1206 AB		  
405 (1.6/1.8 e 2.0)		VKBA 915 ou BAH-0171		  
	4X2 Com ABS Bosch (Rolamento com cubo)	VKBA 3476 ou BAFB 446451 EE		 
	4X2 Sem ABS (Rolamento com cubo)	VKBA 743 ou BAFB 444450 AAB		
	4X4 Sem ABS	VKBA 915 ou BAH-0171		  
	4X2 Com ABS Bendix (Rolamento com cubo)	VKBA 1331 ou BAFB 446451 EB		 
406		VKBA 915 ou BAH-0171		  

PEUGEOT



Rolamentos e kits de roda



































Veículo	Observações	Designação SKF	Rol.	Componentes
...Continuação 406	Com ABS (Rolamento com cubo)	VKBA 3454 ou BAF 4106 BA		
	11/95...10/05 sem ABS (Rolamento com cubo)	VKBA 3477		
504 (2.3) 4X2 Pick-Up Diesel	...89	VKBA 540 ou 32005 X/QVB015 442882/Q		
		VKBA 1312		
Boxer 2.5 e 2.8 (Furgão)	03/94...04/02 (1000 e 1400 kg) Chassi 161944399...	VKBA 1444 ou 32010 X/QCL7CVB026 32011 X/QCL7CVB026		
	03/94...04/02 (1800 kg) Chassi 161944399...	VKBA 3428		2 unid.
	04/02...04/06 (1800 kg) Chassi 161...	VKBA 3641 ou BTH 1011 AB		
	03/94...04/02 (ch 16194400...) e Boxer II 04/02...04/06	VKBA 3642		
Jumper	03/94...04/02 (1000 e 1400 kg) ...Chassi 161944399	VKBA 1444 ou 32010 X/QCL7CVB026 32011 X/QCL7CVB026		
	03/94...04/02 (1800 kg) ...Chassi 161944399	VKBA 3428		2 unid.
	03/94...04/02 (1000 e 1400 kg) Chassi 161944400...	VKBA 3640		
	03/94...04/02 (1800 kg) Chassi 161944400...	VKBA 3641 ou BTH 1011 AB		
	03/94...04/02 (1000 e 1400 kg) Chassi 161944399...	VKBA 3429		
	03/94...04/02 (1800 kg) ...Chassi 161944399	VKBA 3430		
	02/94...04/06 chassi 16194400...	VKBA 3642		
Partner (1.6 e 1.8) gasolina	96...06/00	VKBA 915 ou BAH-0171		
	Sem ABS (Rolamento com cubo)	VKBA 3477		
	Com ABS (Rolamento com cubo)	VKBA 3482		
Clio (1.0 e 1.6)	1.6 Nacional/Importado	VKBA 3596 ou BAH-0094		
	1.0 Nacional/Importado sem ABS	VKBA 3496 ou BT2B 445620 BB		
	Nacional/Importado sem ABS	VKBA 3525 ou BT2B 445539 CC		
	Nacional/importado com ABS	VKBA 969		
Kangoo (1.0 8V/16V e 1.6 8V)		VKBA 3596 ou BAH-0094		
	...03/03 Com ABS Adventure fora de estrada rol. com cubo	VKBA 3506		
	...04/06 Sem ABS	VKBA 976		
Laguna (2.0)	16V 97... Rolamento com cubo	VKBA 3492		

PEUGEOT - Continuação

RENAULT



Rolamentos e kits de roda

Veículo	Observações	Designação SKF	Rol.	Componentes
...Continuação Laguna (2.0)	8V Com suspensão reforçada e 16V...97 (Rolamento com cubo)	VKBA 3495		
	8V Sem ABS sem AC e sem suspensão reforçada	VKBA 3596 ou BAH-0094		 
	8V Freio a tambor sem ABS	VKBA 976		
	8V Freio a disco 5 furos (Rolamento com cubo)	VKBA 3464		
	16V ...97 Freio a disco com ABS 5 furos (Rolamento com cubo)	VKBA 3468		
	8V Freio a disco com ABS 4 furos rolamento com cubo	VKBA 3469		
	16V 97...; 3.0 24V ...99 Freio a disco (Rolamento com cubo)	VKBA 3542		
	24V - 99... Freio a disco (Rolamento com cubo)	VKBA 3561		
Logan e Sandero (1.0/1.6 8V e 16V)		VKBA 3596 ou BAH-0094		 
		VKBA 3525 ou BT2B 445539 CC		
Master (2.2/2.5/2.8 e 3.0)		VKBA 3613		 
		VKBA 3614		  
Mégane e Mégane Sedan (1.6 e 2.0 8V e 16V)	16V (Rolamento com cubo)	VKBA 3495		 
	8V	VKBA 3596 ou BAH-0094		
	Novo Mégane motores F4R770/F4R771	VKBA 3637		 
	Com ABS freio a disco	VKBA 969		 
	Sem ABS Freio a tambor (Rolamento com cubo)	VKBA 3225		
	Novo Mégane motores F4R770/F4R771	VKBA 3639		  
R 19 (1.6 e 1.8)	...95	VKBA 3596 ou BAH-0094		
	Com ABS freio a disco	VKBA 969		 
	Sem ABS freio a tambor	VKBA 3525 ou BT2B 445539 CC		
R 21 (1.6/2.0/2.1D e 2.2)		VKBA 966		
	Sem ABS (Rolamento com cubo)	VKBA 968		
	Com ABS cubo com 4 furos (Rolamento com cubo)	VKBA 1494		 
Scénic (1.6 16V e 2.0 8V/16V)	8V	VKBA 3596 ou BAH-0094		 
	1.6 16V Sem ABS ...00 (Rolamento com cubo)	VKBA 968		

RENAULT - Continuação



Rolamentos e kits de roda

Veículo	Observações	Designação SKF	Rol.	Componentes	
RENAULT - Continuação	...Continuação Scénic (1.6 16V e 2.0 8V/16V)	Com ABS ...00 (Rolamento com cubo)	VKBA 3491		
	Traffic (2.1/2.2 e 2.5)		VKBA 909		
	Twingo 1.0 e 1.2	03/93...01/06	30205 J2/Q 32007 X/Q		
	03/93...01/06 Sem ABS freio a tambor	VKBA 3496 ou BT2B 445620 BB			
		VKBA 3525 ou BT2B 445539 CC			
SEAT	Cordoba/Ibiza GLX e SXE		VKBA 1358 ou BAHB 311443 B		2 unid.
	96...09/99		VKBA 4529 ou LM 11749/710/QVCO27 L 45449F/410/Q		
SUBARU	Legacy (2.0 e 2.2 16V)	4X4	VKBA 3235		2 unid.
		4X4	VKBA 3236		3 unid.
SUZUKI	Vitara (1.6 e 2.0)		VKBA 3219		2 unid.
			VKBA 3220		2 unid.
TOYOTA	Bandeirante	...83	2788/QCL7C + 2720/QCL7C		
		83...	LM 102949/910/Q		
		83...	JLM 104948 AA/910 AA/Q		
		83...	JLM 104948 AA/910 AA/Q		
		83...	LM 102949/910/Q		
	Corolla (1.6 Importado, 1.8 Nacional)	Com ABS ...02	VKBA 3729		
	Sem ABS ...02	VKBA 3730		2 unid.	
	Sem ABS ...02 (Rolamento com cubo)	VKBA 3731			
Hilux (2.8 diesel, 3.0 gasolina)	4X4 Freio a disco	VKBA 1951 ou JLM 104948 AA/910 AA/Q LM 102949/910/Q			
	4X4	VKBA 3740 ou 6308-2RS1/C5		2 unid. 4 unid.	
TROLLER	TDI		JLM 104948 AA/910 AA/Q		
			LM 102949/910/Q		
			JLM 104948 AA/910 AA/Q		
			LM 102949/910/Q		



Rolamentos e kits de roda

Veículo	Observações	Designação SKF	Rol.	Componentes
Apollo		VKBA 4687 ou BT1B 332541 AB/Q	• •	2 unid.
		VKBA 4528 ou LM 11749/710/QVC027 L 45449F/410/Q	• •	
Bora (2.0)		VKBA 3455 ou BAF-0049 C		
	Rolamento com cubo	VKBA 3456 ou BAF 4104 BBX		
Brasília 1500 e 1600, Fusca 1300, 1300L, 1500 e 1600, Variant I	...74	30304 J2/Q 30305 J2	• •	
	74...	LM 11749/710/QVC027 L 45449F/410/Q	• •	
		VKBA 603 ou 6306/C3		3 unid.
Fox, CrossFox e SpaceFox (1.0 e 1.6)		VKBA 4501 ou BAH-0036		
	Rolamento com cubo (Fox ...07/07, CrossFox e SpaceFox)	VKBA 3567		
	08/07... (Fox)	VKBA 4529 ou LM 11749/710/QVC027 L 45449F/410/Q	• •	
Gol refrig. a água, Parati	...04/94	VKBA 4500 ou BAHB 311315 ADB		2 unid.
	05/94... Inclusive Novo Gol	VKBA 4501 ou BAH-0036		
	Inclusive Novo Gol	VKBA 4529 ou LM 11749/710/QVC027 L 45449F/410/Q	• •	
Gol refrig. a ar (1.3 e 1.6)		VKBA 4500 ou BAHB 311315 ADB		2 unid.
		VKBA 4529 ou LM 11749/710/QVC027 L 45449F/410/Q	• •	
Golf A4 (Importado 08/98...07/99 e Nacional 08/99...)		VKBA 3455 ou BAH-0049 C		
	Com e sem ABS (Rolamento com cubo)	VKBA 3456 ou BAF 4104 BBX		
Golf Importado (02/94...07/98)		VKBA 1358 ou BAHB 311443 B		2 unid.
		VKBA 4529 ou LM 11749/710/QVC027 L 45449F/410/Q	• •	
Kombi 1500 e 1600	74....	VKBA 4505 ou LM 11949/910/Q LM 67048/010/Q	• •	
	02/78...	6207/C3	• •	
Logus (1.6 e 1.8)		VKBA 1432 ou BAH-0036		
		VKBA 4533 ou BT1B 329013 A/Q	• •	
New Beetle	01/98...	VKBA 3455 ou BAH-0049 C		
	01/98... (Rolamento com cubo)	VKBA 3456 ou BAF 4104 BBX		
Passat e Variant Importado (1.8/1.8 Turbo, 2.0 e 2.8)	20V 98...	VKBA 1355 ou BAHB 633815 AA		2 unid.

VW



Rolamentos e kits de roda

Veículo	Observações	Designação SKF	Rol.	Componentes
...Continuação Passat e Variant Importado (1.8/1.8 Turbo, 2.0 e 2.8)	2.8 04/98...	VKBA 1356 ou BAH-0011 D		2 unid.
	2.0 11/94...07/97	VKBA 1358 ou BAHB 311443 B		2 unid.
	2.8 11/94 ...07/97	VKBA 1491 ou BAH 0168		2 unid.
	04/98... (Rolamento com cubo)	VKBA 3489		
	11/94...07/97	VKBA 4529 ou LM 11749/710/QVC027 L 45449F/410/Q		
Passat (1.5/1.6 e 1.8)	...88	VKBA 4500 ou BAHB 311315 ADB		2 unid.
		VKBA 4529 ou LM 11749/710/QVC027 L 45449F/410/Q		
Pointer (1.8 e 2.0)		VKBA 1432 ou BAH-0036		
		VKBA 4533 ou BT1B 329013 A/Q		
Polo	...93	VKBA 577 ou BAHB 311316 B		2 unid.
	94...	VKBA 906 ou BAH-0023		
	05/02... (Rolamento com cubo)	VKBA 3548 ou BAF-0058 B		
	Sedan 11/02... (Rolamento com cubo)	VKBA 3567		
	96... Classic	VKBA 1358 ou BAHB 311443 B		2 unid.
	...08/00 Classic	VKBA 4529 ou LM 11749/710/QVC027 L 45449F/410/Q		
Santana e Santana Quantum (1.6/1.8 e 2.0)	...04/94	VKBA 4500 ou BAHB 311315 ADB		2 unid.
	05/94...	VKBA 4501 ou BAH-0036		
		VKBA 4529 ou LM 11749/710/QVC027 L 45449F/410/Q		
Saveiro e Voyage (1.6 e 1.8)	...04/94	VKBA 4500 ou BAHB 311315 ADB		2 unid.
	05/94... inclusive Saveiro geração IV e Novo Voyage 2008...	VKBA 4501 ou BAH-0036		
	Inclusive geração 4 e Novo Voyage 2008...	VKBA 4529 ou LM 11749/710/QVC027 L 45449F/410/Q		
Van (1.6 e 1.8)	11/98...	VKBA 1358 ou BAHB 311443 B		2 unid.
	11/98...	LM 11949/910/Q L 45449F/410/Q		
Variant II		BAHB 311315 ADB		
		NU 206 ECP/C3		
		6206/C3		

VW - Continuação





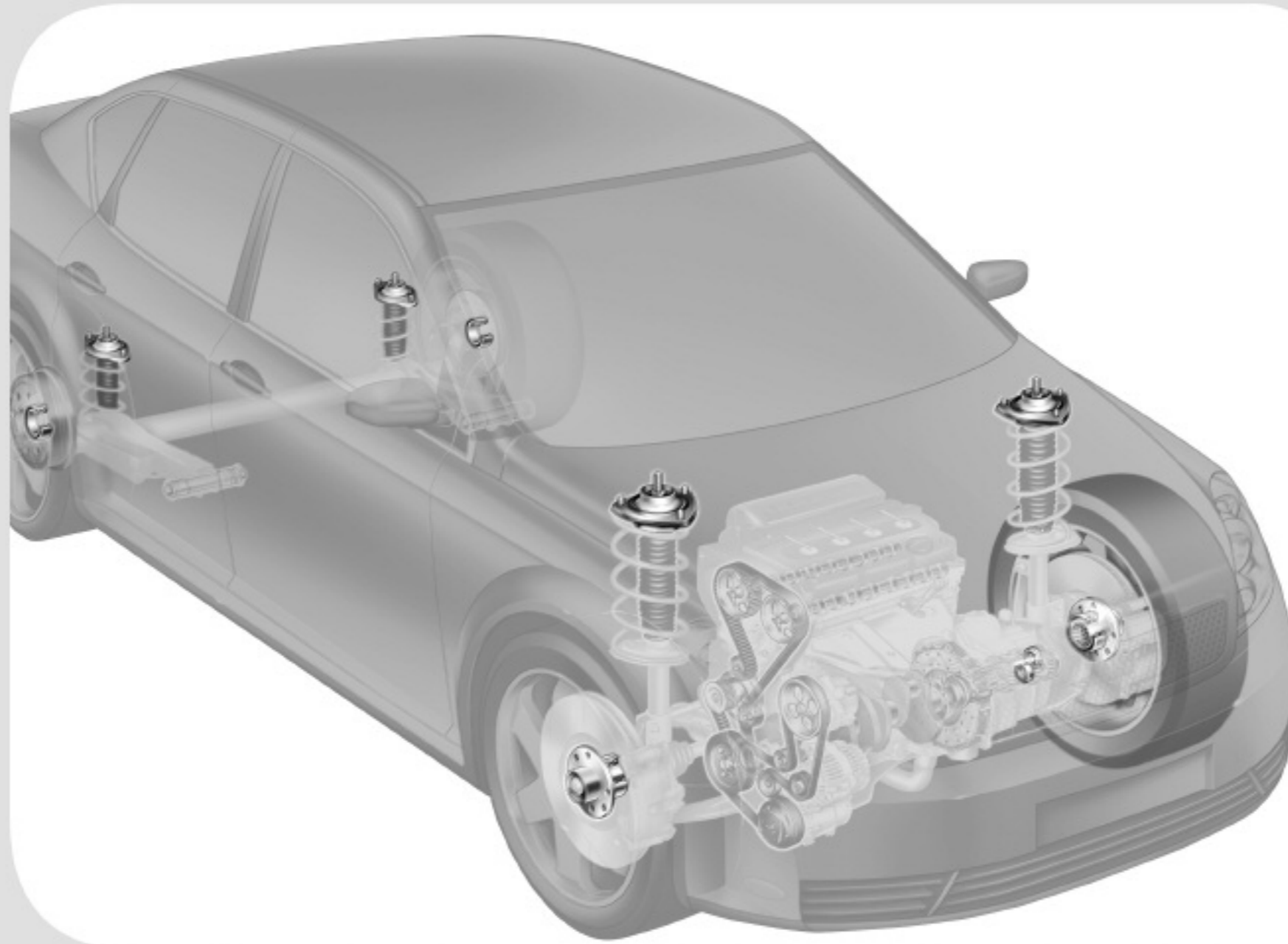









Rolamentos para automóveis e utilitários





























Aplicações diversas











Aplicações diversas

	Veículo	Aplicação	Observações	Designação SKF	Qt.	Rol.
ALFA ROMEO	164 (2.0 e 3.0 V6)	Eixo dianteiro, prato de mola		VKDA 35223	1	
		Eixo dianteiro, semi eixo		62206-2RS1	2	
ASIA	Topic	Câmbio, eixo intermediário		6304-2RS1	1	
		Câmbio, eixo primário		6307-2RS1NR	1	
		Câmbio, eixo secund.	lado esquerdo	6208-2RS1	1	
		Motor, alternador		6303-2RSH/C3HT	1	
	Towner	Câmbio, eixo secund., diant.		6303	1	
		Câmbio, eixo secund., tras.		6303-2RSH	1	
AUDI	A3 (1.6, 1.8 e 1.8 T)	Eixo dianteiro, prato de mola		VKDA 35113	1	
		A6, A6 Avant, A6 Avant Quattro e A6 Quattro	Eixo dianteiro, suspensão		VKD 35021	1
BMW	325 e 328	Eixo dianteiro, prato de mola		VKDC 35802	1	
CHRYSLER	Caravan e Gran Caravan	Embreagem, desengate	90...93	N 4122	1	
	Cherokee e Gran Cherokee	Embreagem, apoio	diesel	6302-2RSH	1	
		Embreagem, apoio	6 cilindros	B 128	1	
		Embreagem, desengate		N 4093	1	
		Diferencial, coroa, lat. dir./esq.		LM 603049/012	2	
	Dakota	Diferencial, coroa, lat. dir.		LM 501349/310/Q	1	
		Diferencial, coroa, lat. esq.		LM 501349/310/Q	1	
		Diferencial, pinhão cônico, tras.		HM 88649/2/610/2/QCL7C	1	
		Diferencial, coroa, lat. dir./esq.		LM 603049/012	2	
	Neon	Embreagem, desengate	95...	N 4166	1	
	Stratus	Embreagem, desengate	95...98	N 4166	1	
	CITROEN	Berlingo (1.8)	Eixo dianteiro, prato de mola	com DH	VKDA 35306	1
Eixo dianteiro, prato de mola			sem DH	VKDA 35307	1	
C3 (1.4 8V e 1.6 16V)		Eixo traseiro, suspensão		VKDA 35316 T	1	
Xantia (2.0 8V/16V)		Eixo dianteiro, semi eixo direito		6006-2RS1	1	
		Eixo traseiro, braço da suspensão		VKDA 23001	1	

Aplicações diversas

















Veículo	Aplicação	Observações	Designação SKF	Qt.	Rol.	
CITROEN - Cont. Xsara Picasso (1.6 8V, 1.8 16V e 2.0 8V/16V)	Eixo dianteiro, prato da mola		VKD 35002	1		
	Eixo dianteiro, semi eixo direito		6006-2RS1	1		
	ZX (1.6 8V, 1.8 8V, 2.0 8V e 2.0 16V)	Eixo dianteiro, prato de mola	sem DH	VKDA 35307	1	
		Eixo dianteiro, semi eixo direito		6006-2RS1	1	
147	Câmbio e diferencial, coroa lateral, dir. e esq.		639058	2		
	Motor, alternador, diant.	Bosch	6203-2RSH/C3HT22VT200	1		
	Motor, alternador, tras.	Bosch	6201-2RSH/C3GJN	1		
	Motor, alternador, tras.	Bosch 70A	62201-2RS1/C3HTVT193	1		
Brava e Doblò	Câmbio, eixo primário e secund., dir.	1.8/1.6 16V	BB1B 631046 B	2		
	Semi-eixo dianteiro	Brava 1.6 16V 99... Doblò 1.6 16V 01...	VKJP 84888	1		
	Câmbio, eixo primário, esq.	1.8 16V	BB1-0016 A	1		
	Diferencial, coroa, lat. dir. e esq.	1.8 16V	32009 X/Q	2		
	Diferencial, coroa, lat. dir. e esq.	1.6 16V	639058	2		
	Eixo dianteiro, prato de mola		VKDC 35204	1		
FIAT Ducato (1.9D, 2.5D/TD, 2.8 D/TD)	Eixo dianteiro, prato de mola	...01/94	VKD 35016	1		
	Eixo dianteiro, prato de mola	02/94....	VKD 35017	1		
Elba	Câmbio e diferencial, coroa lateral, dir. e esq.		639058	2		
	Motor, alternador, diant.	Bosch	6203-2RSH/C3HT22VT200	1		
	Semi-eixo dianteiro	1.5 87...	VKJP 84888	1		
	Motor, alternador, tras.	Bosch	6201-2RSH/C3GJN	1		
	Motor, alternador, tras.	Bosch 70A	62201-2RS1/C3HTVT193	1		
	Motor, bomba d'água, dir.	1.6	62302-2RS1/C3	1		
	Motor, bomba d'água, esq.	1.6	62202-2RS1/C3	1		
Fiorino	Câmbio e diferencial, coroa lateral, dir. e esq.		639058	2		
	Câmbio e diferencial, eixo primário, dir.	88...	BB1B 362668 A	1		
	Câmbio e diferencial, eixo secund., dir.	88...	BC1B 635251	1		

Aplicações diversas

Veículo	Aplicação	Observações	Designação SKF	Qt.	Rol.
...Continuação Fiorino	Motor, alternador, diant.	Bosch	6203-2RSH/C3HT22VT200	1	
	Motor, alternador, tras.	Bosch	6201-2RSH/C3GJN	1	
	Motor, alternador, tras.	Bosch 70A	62201-2RS1/C3HTVT193	1	
	Motor, bomba d'água, dir.	1.6	62302-2RS1/C3	1	
	Motor, bomba d'água, esq.	1.6	62202-2RS1/C3	1	
	Semi-eixo dianteiro	1.5 87...	VKJP 84888	1	
	Semi-eixo dianteiro	1.0/1.0 Fire	VKJP 84887	1	
Marea, Marea Turbo, Marea Weekend	Câmbio, eixo primário e secund., esq.		BB1-0016 A	2	
	Câmbio, eixo primário, dir.	1.8 16V	BB1B 631046 B	1	
	Diferencial, coroa, lat. dir. e esq.		32009 X/Q	2	
	Eixo dianteiro, prato de mola		VKDC 35204	1	
	Motor, eixo virabrequim, comando	2.0 20V	6204 ETN9/C3H	2	
	Semi-eixo dianteiro	1.6 16V 05...	VKJP 84888	1	
Oggi	Câmbio e diferencial, coroa lateral, dir. e esq.		639058	2	
	Motor, alternador, diant.	Bosch	6203-2RSH/C3HT22VT200	1	
	Motor, alternador, tras.	Bosch	6201-2RSH/C3GJN	1	
	Motor, alternador, tras.	Bosch 70A	62201-2RS1/C3HTVT193	1	
Palio, Palio Weekend, Palio Weekend Adventure	Câmbio e diferencial, coroa lateral, dir. e esq.	exceto Adventure	639058	2	
	Câmbio e diferencial, eixo prim. e secund., esq.		BB1B 631046 B	1	
	Câmbio e diferencial, eixo primário, dir.		BB1-0016 A	1	
	Eixo traseiro, bandeja		BCAB 326332 B	2	
	Semi-eixo dianteiro	1.0/1.5 e 1.6 (Todos 8V/16V 96...)	VKJP 84888	1	
	Semi-eixo dianteiro	1.0/1.3 e 1.4 (Todos 8V/16V Fire)	VKJP 84887	1	
Pick-up	Câmbio e diferencial, coroa lateral, dir. e esq.		639058	2	
	Motor, alternador, diant.	Bosch	6203-2RSH/C3HT22VT200	1	
	Motor, alternador, tras.	Bosch	6201-2RSH/C3GJN	1	













FIAT - Continuação

Aplicações diversas

Veículo	Aplicação	Observações	Designação SKF	Qt.	Rol.
...Continuação Pick-up	Motor, alternador, tras.	Bosch 70A	62201-2RS1/C3HTVT193	1	
	Motor, bomba d'água, dir.	1.6	62302-2RS1/C3	1	
	Motor, bomba d'água, esq.	1.6	62202-2RS1/C3	1	
Prêmio	Câmbio e diferencial, coroa lateral, dir. e esq.		639058	2	
	Câmbio e diferencial, eixo primário, dir.		BB1B 362668 A	1	
	Motor, alternador, diant.	Bosch	6203-2RSH/C3HT22VT200	1	
	Motor, alternador, tras.	Bosch	6201-2RSH/C3GJN	1	
	Motor, alternador, tras.	Bosch 70A	62201-2RS1/C3HTVT193	1	
	Motor, bomba d'água, dir.	1.6	62302-2RS1/C3	1	
	Motor, bomba d'água, esq.	1.6	62202-2RS1/C3	1	
	Semi eixo diant.	1.5 87...	VKJP 84888	1	
Siena	Câmbio e diferencial, coroa lateral, dir. e esq.		639058	1	
	Câmbio e diferencial, eixo prim. e secund., esq.		BB1B 631046 B	1	
	Câmbio e diferencial, eixo primário, dir.		BB1-0016 A	1	
	Eixo traseiro, bandeja		BCAB 326332 B	2	
	Semi-eixo dianteiro	1.0/1.5 e 1.6 (Todos 8V/16V 96...)	VKJP 84888	1	
	Semi-eixo dianteiro	1.0/1.3 e 1.4 (Todos 8V/16V Fire)	VKJP 84887	1	
Spazio	Câmbio e diferencial, coroa lateral, dir. e esq.		639058	2	
	Motor, alternador, diant.	Bosch	6203-2RSH/C3HT22VT200	1	
	Motor, alternador, tras.	Bosch	6201-2RSH/C3GJN	1	
	Motor, alternador, tras.	Bosch 70A	62201-2RS1/C3HTVT193	1	
Strada	Semi-eixo dianteiro	1.5/1.6 (Todos 8V/16V 96...)	VKJP 84888	1	
Tempra	Câmbio 5 marchas e difer., eixo prim., esq.		BA2B 633668 A	1	
	Câmbio 5 marchas e difer., eixo secund., dir.		BC1B 635251	1	
	Diferencial (...92), coroa, lateral dir. e esq.		32009 X/Q	2	
	Eixo dianteiro, semi árvore central		63006-2RS1/C4	1	

FIAT - Continuação











Aplicações diversas

Veículo	Aplicação	Observações	Designação SKF	Qt.	Rol.	
FIAT - Continuação	...Continuação Tempra	Motor, alternador, diant.	Bosch	6303-2RSH/C3HT	1	
		Motor, alternador, tras.	Bosch	62201-2RS1/C3HTVT193	1	
	Tipo	Câmbio e diferencial, coroa lateral, dir. e esq.	2.0 SLX e 16V	32009 X/Q	2	
		Câmbio e diferencial, coroa lateral, dir. e esq.	1.6	639058	2	
		Câmbio e diferencial, eixo primário, dir.	1.6	BB1B 630857	1	
		Motor, árvore, balanceamento dinâmico	2.0 SLX e 16V	6204 ETN9/C3H	1	
		Motor, polia tensora, balanceamento dinâmico	2.0 SLX e 16V	6005-2RS1/C3HHT22	1	
		Motor, polia tensora, balanceamento dinâmico	2.0 SLX e 16V	63008-2RS1/HT	1	
		Semi-eixo dianteiro	1.6	VKJP 84887	1	
	Uno	Câmbio e diferencial, coroa lateral, dir. e esq.		639058	2	
		Câmbio e diferencial, eixo primário, dir.	câmbio C513-Uno 1.0 EP (...95); câmbio C513-Uno 1.5 e 1.6 (94...)	BB1-0016 A	1	
		Câmbio e diferencial, eixo primário, dir.		BB1B 362668 A	1	
		Câmbio e diferencial, eixo primário, esq.	câmbio C513-Uno 1.0 EP (...95); câmbio C513-Uno 1.5 e 1.6 (94...)	BB1B 631046 B	1	
Câmbio e diferencial, eixo secund., esq.		câmbio C513-Uno 1.0 EP (...95); câmbio C513-Uno 1.5 e 1.6 (94...)	BB1B 631046 B	1		
Motor, alternador, diant.		Bosch	6203-2RSH/C3HT22VT200	1		
Motor, alternador, tras.		Bosch	6201-2RSH/C3GJN	1		
Motor, alternador, tras.		Bosch 70A	62201-2RS1/C3HTVT193	1		
Motor, bomba d'água, dir.		1.6	62302-2RS1/C3	1		
Motor, bomba d'água, esq.		1.6	62202-2RS1/C3	1		
FORD	Belina I (...78) e Corcel I (...78)	Semi-eixo dianteiro	1.0/1.0 Fire	VKJP 84887	1	
		Semi-eixo diant.	1.5 87...	VKJP 84888	1	
		Diferencial, coroa, lat. dir.		30207 J2/Q	1	
		Direção, pinhão cônico, tras.		6001	1	
		Motor, alternador, diant.	Wapsa	6203-2RSH/C3HT22VT200	1	
Motor, alternador, tras.	...73 (Wapsa)	6200-2RS1/C3GJN	1			
Motor, bomba d'água, diant.		30203 J2	1			

Aplicações diversas

Veículo	Aplicação	Observações	Designação SKF	Qt.	Rol.	
FORD - Continuação	...Continuação Belina I (...78) e Corcel I (...78)	Motor, bomba d'água, tras.	32304 J2/Q	1		
	Belina II (79...) e Corcel II (79...)	Caixa de transferência, eixo de saída		6206/C3	1	
		Câmbio 4 marchas, eixo primário, tras.		32304 J2/Q	1	
		Câmbio 4 marchas, eixo primário, diant.		30203 J2	1	
		Diferencial, coroa, lat. esq.		30207 J2/Q	1	
		Direção, pinhão cônico, tras.		6001	1	
		Motor, alternador, diant.	Wapsa	6203-2RSH/C3HT22VT200	1	
	Courier	Câmbio e diferencial, coroa lateral, dir.	5 marchas câmbio IB5	BT1-0017 A/Q	1	
		Câmbio e diferencial, coroa lateral, esq.	5 marchas câmbio IB5	LM 29749 F/711/Q	1	
		Câmbio e diferencial, eixo primário, dir.	5 marchas câmbio IB5	BB1-0078	1	
		Câmbio e diferencial, eixo primário, esq.	5 marchas câmbio IB5	BB1B 362937 B	1	
		Câmbio e diferencial, eixo secund., esq.	5 marchas câmbio IB5	BB1B 362711 A	1	
		Motor, alternador, diant.	1.0 e 1.3 75A/90A, com AC	6303-2RSH/C3HT	1	
		Motor, alternador, diant.	1.0 e 1.3 75A, sem AC	BB1-3065 C	1	
		Motor, alternador, tras.	1.0 e 1.3 75A, sem AC	6003-2RS1/C3GJN	1	
		Motor, alternador, tras.	1.0 e 1.3 75A/90A, com AC	6203-2RSH/C3HT22VT200	1	
	Del Rey e Pampa	Caixa de transferência, eixo de saída		6206/C3	1	
		Câmbio 4 marchas, eixo primário, tras.		32304 J2/Q	1	
		Câmbio 4 marchas, eixo primário, diant.		30203 J2	1	
		Diferencial, coroa, lat. dir. e esq.	Pampa AP 1.8 (5 marchas)	LM 300849/811/Q	1	
Diferencial, coroa, lat. esq.			30207 J2/Q	1		
Direção, pinhão cônico, tras.			6001	1		
Motor, alternador, diant.		Wapsa	6203-2RSH/C3HT22VT200	1		
Escort e Verona (...93)	Câmbio 5 marchas e difer., coroa lat., dir. e esq.	AP 1.8 e 1.8S	LM 29749/710/Q	1		
	Câmbio 5 marchas e difer., eixo secund., dir.	AP 1.8 e 1.8S	L 45449 F/410/Q	1		
	Câmbio 5 marchas e difer., eixo secund., interm.	AP 1.8 e 1.8S	330757 C/Q	1		

Aplicações diversas

























Veículo	Aplicação	Observações	Designação SKF	Qt.	Rol.	
...Continuação Escort e Verona (...93)	Câmbio e diferencial, coroa lateral, dir. e esq.	4/5 marchas 1.6 AE/CHT	LM 29749 F/711/Q	1		
	Câmbio e diferencial, eixo primário, dir.	4/5 marchas 1.6 AE/CHT	BB1B 362668 A	1		
	Câmbio e diferencial, eixo primário, esq.	4/5 marchas 1.6 AE/CHT	BB1B 362937 B	1		
	Câmbio e diferencial, eixo secund., esq.	4/5 marchas 1.6 AE/CHT	BB1B 362711 A	1		
	Direção, pinhão cônico, tras.		6202/C2	1		
	Eixo dianteiro, prato da mola		BD1B 1820200 A	1		
	Motor, alternador, diant.	AE/CHT 1.6	6203-2RSH/C3HT22VT200	1		
	Motor, alternador, tras.	84..., AE/CHT 1.6	6201-2RSH/C3GJN	1		
	Escort e Verona (94...)	Câmbio MQ 5 marchas e difer., coroa lat., dir. e esq.		BT1B 328612 C/QCL7C	2	
		Câmbio MQ 5 marchas e difer., eixo prim., interm.		BT1B 328236 A /QCL7CVC027	1	
		Câmbio MQ 5 marchas e difer., eixo secund., dir.		L 45449 F/410/Q	1	
		Câmbio MQ 5 marchas e difer., eixo secund., esq.		LM 29749/710/Q	1	
		Motor, alternador, diant.	8V e 16V	6303-2RSH/C3	1	
		Motor, alternador, tras.	20V 95A	6201-2RSH/C3GJN	1	
Motor, alternador, tras.		1.8 16V 70A (97...)	6203-2RSH/C3HT22VT200	1		
Explorer	Diferencial dianteiro, coroa, lat. dir. e esq.	4X4	LM 501349/314/Q	1		
	Diferencial dianteiro, pinhão cônico, diant.	4X4	HM 88649/2/620/2/QCL7C	1		
	Diferencial traseiro, pinhão cônico, diant.	4X4	M 88048/2/010/2/QCL7C	1		
	Diferencial traseiro, pinhão cônico, tras.	4X4	M 802048/011/QCL7C	1		
F 100 (...87)	Diferencial Albarus (Dana), coroa, lat. dir. e esq.		25577/2/25523/2/Q	2		
	Diferencial Albarus (Dana), pinhão cônico, tras.	67...	31594/2/31520/2	1		
	Direção, coluna, inf.	71...	6307 NR	1		
	Motor, alternador, diant.	opção 6203-2Z/C3	6203-2RSH/C3HT22VT200	1		
F-1000 (79...)	Câmbio 5 marchas, eixo intermediário, tras.	89...	6308 NR	1		
	Câmbio 5 marchas, eixo secund.	89...	6308 NR	1		
	Diferencial Albarus (Dana), coroa, lat. dir. e esq.	Mod. 44-1 (...89)	25577/2/25523/2/Q	1		

FORD - Continuação

Aplicações diversas









Veículo	Aplicação	Observações	Designação SKF	Qt.	Rol.	
FORD - Continuação	...Continuação F-1000 (79...)	Diferencial Albarus (Dana), pinhão cônico, tras.	Mod. 44-1 (...89)	31594/2/31520/2	1	
		Diferencial Albarus (Dana), pinhão cônico, tras.	Mod. 44-1 4X2 (90...) e 4x4 (93...)	HM 88649/2/610/2/QCL7C	1	
		Diferencial Braseixos, coroa, lat. dir. e esq.	84...86	368 A/362 X/Q	1	
		Diferencial Braseixos, pinhão cônico, diant.	84...86	M 88048/2/010/2/QCL7C	1	
		Diferencial Braseixos, pinhão cônico, tras.	84...86	M 802048/011/QCL7C	1	
		Motor, alternador, diant.		6203-2RSH/C3HT22VT200	1	
	F-2000 (80...)	Câmbio 4 marchas, eixo secund.	...82	6308 NR	1	
		Câmbio 5 marchas, eixo intermediário, tras.	82...	6308 NR	1	
		Câmbio 5 marchas, eixo secund.	82...	6308 NR	1	
		Diferencial Albarus (Dana), coroa, lat. dir. e esq.		387 A/382 A/Q	2	
		Diferencial Albarus (Dana), pinhão cônico, diant.		HM 88542/2/510/2/QCL7C	1	
		Diferencial Albarus (Dana), pinhão cônico, tras.		HM 803146/2/110/2/QCL7C	1	
	F-350	Câmbio 4 marchas, eixo secund.	...77	6308 NR	1	
		Diferencial, coroa, lat. dir.	59...77	387 A/382 A/Q	1	
		Diferencial, pinhão cônico, tras.	59...77	HM 807046/010/QCL7C	1	
		Direção, coluna, inf.	71...	368 A/362 A/Q	1	
		Motor, alternador, diant.	opção 6203-2Z/C3	6203-2RSH/C3HT22VT200	1	
	F-400	Câmbio 4 marchas, eixo secund.		6308 NR	1	
Diferencial Braseixos, coroa, lat. dir. e esq.			387 A/382 A/Q	2		
Diferencial Braseixos, pinhão cônico, tras.			HM 807046/010/QCL7C	1		
Direção, coluna, inf.		71...	6307 NR	1		
Motor, alternador, diant.		opção 6203-2Z/C3	6203-2RSH/C3HT22VT200	1		
F 4000 (75...)	Câmbio 4 marchas, eixo secund.	...82	6308 NR	1		
	Câmbio 5 marchas, eixo intermediário, tras.	82...	6308 NR	1		
	Câmbio 5 marchas, eixo secund.	82...	6308 NR	1		

Aplicações diversas

Veículo	Aplicação	Observações	Designação SKF	Qt.	Rol.
...Continuação F 4000 (75...)	Diferencial Albarus (Dana), coroa, lat. dir. e esq.		387 A/382 A/Q	2	
	Diferencial Albarus (Dana), pinhão cônico, diant.		HM 88542/2/510/2/QCL7C	1	
	Diferencial Albarus (Dana), pinhão cônico, tras.		HM 803146/2/110/2/QCL7C	1	
	Motor, alternador, diant.		6203-2RSH/C3HT22VT200	1	
Fiesta e Ka	Câmbio e diferencial, coroa lateral, dir.	5 marchas câmbio IB5	BT1-0017 A/Q	1	
	Câmbio e diferencial, coroa lateral, esq.	5 marchas câmbio IB5	LM 29749 F/711/Q	1	
	Câmbio e diferencial, eixo primário, dir.	5 marchas câmbio IB5	BB1-0078	1	
	Câmbio e diferencial, eixo primário, esq.	5 marchas câmbio IB5	BB1B 362937 B	1	
	Câmbio e diferencial, eixo secund., esq.	5 marchas câmbio IB5	BB1B 362711 A	1	
	Eixo dianteiro, prato de mola	Inclusive Novo Ka	VKDA 35407	1	
	Motor, alternador, diant.	1.0 e 1.3 75A/90A, com AC	6303-2RSH/C3HT	1	
	Motor, alternador, diant.	1.0 e 1.3 75A, sem AC	BB1-3065 C	1	
	Motor, alternador, tras.	1.0 e 1.3 75A, sem AC	6003-2RS1/C3GJN	1	
Motor, alternador, tras.	1.0 e 1.3 75A/90A, com AC	6203-2RSH/C3HT22VT200	1		
Jeep Willys 4X2 e 4X4 (60...83)	Caixa de transferência, eixo secund., tras	4X4	14131/14276/Q	2	
	Câmbio 3 e 4 marchas, eixo secund., tras.		6206/C3	1	
	Diferencial, coroa, lat. dir. e esq.		25577/2/25523/2/Q	2	
	Diferencial, pinhão cônico, tras.		31594/2/31520/2	1	
	Eixo dianteiro, pino da manga de eixo	4X4	11590/11520/Q	2	
	Motor, alternador, diant.	Wapsa	6203-2RSH/C3HT22VT200	1	
	Motor, alternador, diant.	Opcional 6203-2Z/C3 (Bosch)	6203-2RSH/C3HT22VT200	1	
	Motor, alternador, tras.	73... Wapsa	6200-2RS1/C3GJN	1	
	Motor, alternador, tras.	Opcional 6203-2Z/C3 (Bosch)	6201-2RSH/C3GJN	1	
	Motor, dínamo, diant.	60...65	6203-2RSH/C3HT22VT200	1	
	Motor, dínamo, diant. e tras.	64...65	6202	2	
Mondeo (93...)	Câmbio e diferencial, eixo primário, dir.	5 marchas - Manual	1982 F/1924 A/QVQ519	1	

FORD - Continuação

Aplicações diversas

Veículo	Aplicação	Observações	Designação SKF	Qt.	Rol.
...Continuação Mondeo (93...)	Câmbio e diferencial, eixo primário, esq.	5 marchas - Manual	BT1-0044 B/QCL7C	1	
	Eixo dianteiro, prato da mola	Somente rolamento	VKD 35013	1	
	Eixo dianteiro, prato de mola	Rolamento + acessórios	VKDA 35402	1	
F-75 e Rural 4X2 e 4X4	Caixa de transferência, eixo secund., tras.	4X4	14131/14276/Q	2	
	Câmbio 3 e 4 marchas, eixo secund., tras.		6206/C3	1	
	Diferencial, coroa, lat. dir. e esq.		25577/2/25523/2/Q	2	
	Diferencial, pinhão cônico, tras.		31594/2/31520/2	1	
	Eixo dianteiro, pino da manga de eixo	4X4	11590/11520/Q	4	
	Motor, alternador, diant.	Wapsa	6203-2RSH/C3HT22VT200	1	
	Motor, alternador, diant.	Opcional 6203-2Z/C3 (Bosch)	6203-2RSH/C3HT22VT200	1	
	Motor, alternador, tras.	73... Wapsa	6200-2RS1/C3GJN	1	
	Motor, alternador, tras.	Opcional 6203-2Z/C3 (Bosch)	6201-2RSH/C3GJN	1	
	Motor, dínamo, diant.	60...65	6203-2RSH/C3HT22VT200	1	
	Motor, dínamo, diant. e tras.	64...65	6202	2	
Ranger	Diferencial dianteiro, coroa, lat. dir. e esq.	4X4	LM 501349/314/Q	2	
	Diferencial dianteiro, pinhão cônico, diant.	4X4	HM 88649/2/610/2/QCL7C	1	
	Diferencial traseiro, pinhão cônico, diant.	4X4	M 88048/2/010/2/QCL7C	1	
	Diferencial traseiro, pinhão cônico, tras.	4X4	M 802048/011/QCL7C	1	
	Diferencial, pinhão cônico, diant.	4X2	HM 88649/2/610/2/QCL7C	1	
	Diferencial, pinhão cônico, tras.	4X2	M 802048/011/QCL7C	1	
	Diferencial, coroa, lat. dir. e esq.		LM 603049/012	2	
	Motor, alternador, diant.	2.5 D 85A: 10/97...	6203-2RSH/C3HT22VT200	1	
	Motor, alternador, tras.	2.5 D 85A: 10/97...	6003-2RS1/C3GJN	1	
Sierra L, XR3 e S	Câmbio 4 marchas, eixo primário, tras.		63/28	1	
	Câmbio 4 marchas, eixo primário, diant.		6207-ZNR	1	
	Câmbio 5 marchas, eixo primário, tras.		BB1B 362021	1	

FORD - Continuação

Aplicações diversas

Veículo	Aplicação	Observações	Designação SKF	Qt.	Rol.	
FORD - Continuação	...Continuação Sierra L, XR3 e S	Diferencial, coroa, lat. dir. e esq.	LM 501349/314/Q	2		
		Diferencial, pinhão cônico, diant.	HM 88542/2/510/2/QCL7C	1		
		Diferencial, pinhão cônico, tras.	HM 88649/2/620/2/QCL7C	1		
		Motor, alternador, diant.	Indiel	6203-2RSH/C3HT22VT200	1	
		Motor, alternador, tras.	Indiel	6203-2RSH/C3HT22VT200	1	
	Versailles e Versailles Royale (1.8 e 2.0)	Diferencial, coroa, lat. dir. e esq.		LM 300849/811/Q	2	
		Eixo dianteiro, prato de mola		BD1B 1820100 A	1	
		Motor, alternador, diant.	Bosch	6203-2RSH/C3HT22VT200	1	
Motor, alternador, tras.		Bosch	6201-2RSH/C3GJN	1		
GM	A 10	Diferencial traseiro, coroa, lat. dir. e esq.	85... (sem 4X4)	368 A/362 X/Q	2	
		Diferencial traseiro, pinhão cônico, diant.	85... (sem 4X4)	M 802048/011/QCL7C	1	
		Diferencial traseiro, pinhão cônico, diant.	85... (sem 4X4)	M 88048/2/010/2/QCL7C	1	
		Motor, polia tensora, compres. ar		6205-Z	1	
	A 20 (Bonanza e Veraneio)	Diferencial traseiro, coroa, lat. dir. e esq.	85... (sem 4X4)	368 A/362 X/Q	2	
		Diferencial traseiro, pinhão cônico, diant.	88...90	31594/2/31520/2	1	
		Diferencial traseiro, pinhão cônico, diant.	85... (sem 4X4)	M 802048/011/QCL7C	1	
		Diferencial traseiro, pinhão cônico, diant.	85... (sem 4X4)	M 88048/2/010/2/QCL7C	1	
		Motor, polia tensora, compres. ar		6205-Z	1	
	A 40	Câmbio 4 marchas, eixo secund.		6308 NR	1	
		Câmbio 5 marchas, eixo intermediário, tras.	85...91	6308 NR	1	
		Diferencial traseiro, pinhão cônico, diant.	85...	HM 807046/010/QCL7C	1	
Motor, polia tensora, compres. ar			6205-Z	1		
Astra (1.8 e 2.0)	Diferencial, coroa, lat. dir. e esq.		JL 69349/310/Q	2		
	Eixo dianteiro, prato da mola	98....	VKDA 35503	1		
	Eixo traseiro, prato da mola	...98	VKDA 35503	1		
	Motor, alternador, diant.	70A	6203-2RSH/C3HT22VT200	1		

Aplicações diversas

Veículo	Aplicação	Observações	Designação SKF	Qt.	Rol.
...Continuação Astra (1.8 e 2.0)	Motor, alternador, diant.	70 / 120A	BB1-3065 C	1	
	Motor, alternador, tras.	70 / 120A	6003-2RS1/C3GJN	1	
	Motor, alternador, tras.	70A	6203-2RSH/C3HT22VT200	1	
Blazer e Gran Blazer	Câmbio, eixo intermediário	2.2	330757 C/Q	1	
	Diferencial traseiro, pinhão cônico, diant.	2.2	M 802048/011/QCL7C	1	
	Diferencial traseiro, pinhão cônico, tras.		31594/2/31520/2	1	
	Diferencial traseiro, pinhão cônico, tras.	2.2	M 88048/2/010/2/QCL7C	1	
	Motor, alternador, diant.	65 / 75A Bosch	6203-2RSH/C3HT22VT200	1	
	Motor, alternador, diant.	85A Bosch	6303-2RSH/C3HT	1	
	Motor, alternador, tras.	85A Bosch	6001-2RS1/C3LHT23	1	
	Motor, alternador, tras.	65 / 75A Bosch	6201-2RSH/C3GJN	1	
C 10	Diferencial traseiro, coroa, lat. dir. e esq.	85... (sem 4X4)	368 A/362 X/Q	1	
	Diferencial traseiro, pinhão cônico, diant.	85... (sem 4X4)	M 802048/011/QCL7C	1	
	Diferencial traseiro, pinhão cônico, diant.	85... (sem 4X4)	M 88048/2/010/2/QCL7C	1	
	Motor, polia tensora, compres. ar		6205-Z	1	
C 20	Diferencial traseiro, coroa, lat. dir. e esq.	85... (sem 4X4)	368 A/362 X/Q	2	
	Diferencial traseiro, pinhão cônico, diant.	88...90	31594/2/31520/2	1	
	Diferencial traseiro, pinhão cônico, diant.	85... (sem 4X4)	M 802048/011/QCL7C	1	
	Diferencial traseiro, pinhão cônico, diant.	85... (sem 4X4)	M 88048/2/010/2/QCL7C	1	
	Motor, polia tensora, compres. ar		6205-Z	1	
C 40	Câmbio 4 marchas, eixo secund.		6308 NR	1	
	Câmbio 5 marchas, eixo intermediário, tras.	85...91	6308 NR	1	
	Diferencial traseiro, pinhão cônico, diant.	85...	HM 807046/010/QCL7C	1	
	Motor, polia tensora, compres. ar		6205-Z	1	
Calibra (2.0 e 2.2)	Eixo dianteiro, prato de mola		VKDA 35501	1	
Caravan e Opala (2.5 e 4.1)	Câmbio 3 marchas, eixo primário	74...87	6306 ZNR/C3	1	







GM - Continuação

Aplicações diversas

Veículo	Aplicação	Observações	Designação SKF	Qt.	Rol.
...Continuação Caravan e Opala (2.5 e 4.1)	Câmbio 3 marchas, eixo secund.	74...87	6306 NR	1	
	Câmbio 3 marchas, eixo secund., tras.	...70	6206 NR	1	
	Câmbio 4 e 5 marchas, eixo intermediário, tras.	82...91 5 marchas, 4 cil	BK 4020	1	
	Câmbio 4 e 5 marchas, eixo primário	4 marchas (4 cil)	6306-2RS1NR/C3	1	
	Câmbio 4 e 5 marchas, eixo primário, diant.	4 cil. 74...82 (série 109543...) 82... 6 cil. 74...87	6306 ZNR/C3	1	
	Câmbio 4 e 5 marchas, eixo secund.	74...82	6306-2RS1NR/C3	1	
	Câmbio 4 e 5 marchas, eixo secund., tras.	...70	6206 NR	1	
	Câmbio 4 e 5 marchas, eixo secund., tras.	5 marchas, 4 cil	6305/C3	1	
	Câmbio 5 marchas, eixo primário	4 cil	6306-2RS1NR/C3	1	
	Câmbio 5 marchas, eixo secund.	6 cil.	330757 C/Q	1	
	Câmbio 5 marchas, eixo secund., tras.	4 cil.	6305/C3	1	
	Diferencial Albarus (Dana), coroa, lat. dir. e esq.	79...	LM 501349/314/Q	2	
	Diferencial Albarus (Dana), pinhão cônico, diant.	79...	M 86647/610/QCL7C	1	
	Diferencial Albarus (Dana), pinhão cônico, tras.	79...	HM 88649/2/610/2/QCL7C	1	
	Diferencial Albarus (Dana), pinhão cônico, tras.	75...78	M 88048/2/010/2/QCL7C	1	
	Diferencial GM (Braseixos), coroa, lat. dir. e esq.		LM 29749 F/711/Q	2	
	Diferencial GM (Braseixos), pinhão cônico, diant.		M 84548/2/510/2/QVQ506	1	
	Diferencial GM (Braseixos), pinhão cônico, tras.	74... (série 102285...)	M 88048/2/010/2/QCL7C	1	
	Motor, alternador, diant.	opcional 6203-2Z/C3	6203-2RSH/C3HT22VT200	1	
	Motor, carcaça	85...com DH	HK 1712	1	
Celta (1.0 e 1.4)	Câmbio, eixo secund., esq.		6305 ETN9/C3	1	
	Diferencial, coroa, lat. dir. e esq.		32007 X/Q	2	
	Motor, alternador, diant.	55 A 1.0/1.6	6203-2RSH/C3HT22VT200	1	
	Motor, alternador, diant.	55/70/100/120 A	BB1-3065 C	1	
	Motor, alternador, tras.	70/120 A	6003-2RS1/C3GJN	1	
	Motor, alternador, tras.	55 A	6201-2RSH/C3GJN	1	

GM - Continuação

Aplicações diversas

Veículo	Aplicação	Observações	Designação SKF	Qt.	Rol.	
...Continuação Celta (1.0 e 1.4)	Motor, alternador, tras.	55/100 A	6203-2RSH/C3HT22VT200	1		
	Chevette, Chevy 500 e Marajó (1.0, 1.4 e 1.6)	Câmbio 5 marchas (92...), eixo primário		6206 NR	1	
		Câmbio, eixo intermediário, tras.	73...91 (Clark 4 e 5 marchas)	6206 NR	1	
		Câmbio, eixo primário	82... (Clark 4 e 5 marchas)	6206 NR	1	
		Câmbio, eixo primário, tras.	82...91 (Clark 4 e 5 marchas)	6206 NR	1	
		Câmbio, eixo secund., diant.	82...91 (Clark 4 marchas)	BK 4020	1	
		Câmbio, eixo secund., tras.	73...91 (Clark 4 e 5 marchas)	6206 NR	1	
		Diferencial Albarus (Dana), eixo primário, tras.	84...	M 88048/2/010/2/QCL7C	1	
		Diferencial GM (Braseixos), coroa, lat. dir. e esq.		LM 29749 F/711/Q	2	
		Diferencial, pinhão cônico, diant.		M 84548/2/510/2/QVQ506	1	
		Direção, rosca sem fim, sup.	76... (ZF)	6201	1	
		Motor, alternador, diant.	opcional 6203-2Z/C3	6203-2RSH/C3HT22VT200	1	
Corsa (hatch, pick-up e sedan)	Câmbio, eixo secund., esq.		6305 ETN9/C3	1		
	Diferencial, coroa, lat. dir. e esq.		32007 X/Q	2		
	Motor, alternador, diant.	55A 1.0/1.6 (94...)	6203-2RSH/C3HT22VT200	1		
	Motor, alternador, diant.	55/70/100/120 A	BB1-3065 C	1		
	Motor, alternador, tras.	70/120 A	6003-2RS1/C3GJN	1		
	Motor, alternador, tras.	55A	6201-2RSH/C3GJN	1		
	Motor, alternador, tras.	Delco	6202-2RSH/C3GJN	1		
	Motor, alternador, tras.	55/100 A	6203-2RSH/C3HT22VT200	1		
D 10	Diferencial traseiro, coroa, lat. dir. e esq.	85... (sem 4X4)	368 A/362 X/Q	2		
	Diferencial traseiro, pinhão cônico, diant.	85... (sem 4X4)	M 802048/011/QCL7C	1		
	Diferencial traseiro, pinhão cônico, diant.	85... (sem 4X4)	M 88048/2/010/2/QCL7C	1		
D 20 (Bonanza e Veraneio)	Câmbio 4 marchas, eixo secund.		6308 NR	1		
	Câmbio 5 marchas, eixo primário, tras.	Clark 85...91	6308 NR	1		
	Diferencial traseiro, coroa, lat. dir. e esq.	85... (sem 4X4)	368 A/362 X/Q	2		











GM - Continuação

Aplicações diversas

Veículo	Aplicação	Observações	Designação SKF	Qt.	Rol.
...Continuação D 20 (Bonanza e Veraneio)	Diferencial traseiro, pinhão cônico, diant.	88...90	31594/2/31520/2	1	
	Diferencial traseiro, pinhão cônico, diant.	85... (sem 4X4)	M 802048/011/QCL7C	1	
	Diferencial traseiro, pinhão cônico, diant.	88...90 (4X4)	M 802048/011/QCL7C	1	
	Diferencial traseiro, pinhão cônico, diant.	85... (sem 4X4)	M 88048/2/010/2/QCL7C	1	
	Diferencial traseiro, pinhão cônico, diant.	88...90 (4X4)	M 88048/2/010/2/QCL7C	1	
D 40	Câmbio 5 marchas, eixo intermediário, tras.	85...91	6308 NR	1	
	Diferencial traseiro, pinhão cônico, diant.	85...	HM 807046/010/QCL7C	1	
	Motor, polia tensora, compres. ar		6205-Z	1	
Ipanema, Kadett e Monza (1.8 e 2.0)	Diferencial, coroa, lat. dir. e esq.		JL 69349/310/Q	2	
	Eixo dianteiro, prato de mola		VKDC 35505	1	
	Motor, alternador, diant.	Bosch	6203-2RSH/C3HT22VT200	1	
	Motor, alternador, tras.	Bosch	6201-2RSH/C3GJN	1	
Omega e Omega Suprema (2.0, 2.2, 3.0 e 4.1)	Diferencial, pinhão cônico, tras.	2.0 e 2.2	330865 C/QCL7C	1	
	Diferencial, pinhão cônico, tras.	3.0 e 4.1	HM 89449/2/410/2/QCL7C	1	
	Eixo dianteiro, prato de mola		VKD 35005	1	
	Motor, alternador, diant.	70 / 90 A	6201-2RSH/C3GJN	1	
	Motor, alternador, diant.	90A com AC	6303-2RSH/C3HT	1	
	Motor, alternador, diant.	3.0 e 4.1 120A com AC	BB1-3065 C	1	
	Motor, alternador, tras.	70 / 90 A	6201-2RSH/C3GJN	1	
	Motor, alternador, tras.	3.0 e 4.1 120A com AC	6203-2RSH/C3HT22VT200	1	
Motor, alternador, tras.	3.0 e 4.1 120A com AC	6203-2RSH/C3HT22VT200	1		
S-10 (2.2, 2.4, 2.5, 2.8 TD e 4.3)	Câmbio, eixo intermediário	exceto 2.8 TD	330757 C/Q	1	
	Câmbio, eixo secund., diant.	2.2 e 2.5 Gas./Diesel 4 cil.	LM 11949/910/Q	1	
	Câmbio, eixo secund., tras.	2.2 e 2.5 Gas./Diesel 4 cil.	6206-2RS1/C3	1	
	Motor, alternador, diant.	65/ 75A Bosch	6203-2RSH/C3HT22VT200	1	
	Motor, alternador, diant.	85A Bosch	6303-2RSH/C3HT	1	
	Motor, alternador, tras.	85A Bosch	6001-2RS1/C3LHT23	1	







GM - Continuação

Aplicações diversas





















Veículo	Aplicação	Observações	Designação SKF	Qt.	Rol.	
...Continuação S-10 (2.2, 2.4, 2.5, 2.8 TD e 4.3) Silverado	Motor, alternador, tras.	65/ 75A Bosch	6201-2RSH/C3GJN	1		
	Câmbio, eixo intermediário, tras.		6306 NR	1		
	Câmbio, eixo primário, diant.		6207-ZN/C3	1		
	Diferencial, pinhão cônico, diant.	Eaton	M 86649/2/610/2/QVQ506	1		
	Diferencial, pinhão cônico, tras.	Transax	31594/2/31520/2	1		
	Diferencial, pinhão cônico, tras.	Eaton	M 802048/011/QCL7C	1		
	Diferencial, coroa, lat. dir. e esq.	Eaton	LM 603049/012	2		
	Motor, alternador, diant.	Bosch 65/75 A	6203-2RSH/C3HT22VT200	1		
Tigra (1.4 e 1.6)	Motor, alternador, tras.	Bosch 65/75 A	6201-2RSH/C3GJN	1		
	Diferencial, coroa, lat. dir. e esq.		32007 X/Q	2		
	Motor, alternador, diant.	55/ 70/ 100/ 120 A	BB1-3065 C	1		
	Motor, alternador, tras.	70/ 120 A	6003-2RS1/C3GJN	1		
	Motor, alternador, tras.	55 A	6201-2RSH/C3GJN	1		
Motor, alternador, tras.			6203-2RSH/C3HT22VT200	1		
	Vectra (2.0, 2.2 e 2.4)	Diferencial, coroa, lat. dir. e esq.		JL 69349/310/Q	2	
		Motor, alternador, diant.	70/ 120 A	6303-2RSH/C3HT22	1	
		Motor, alternador, diant.	70/ 120 A	BB1-3065 C	1	
		Motor, alternador, tras.	70/ 120 A	6003-2RS1/C3GJN	1	
Motor, alternador, tras.		70/ 120 A (10/93...09/99)	6203-2RSH/C3HT22VT200	1		
Zafira (1.8 e 2.0)	Diferencial, coroa, lat. dir. e esq.		JL 69349/310/Q	2		
	Eixo dianteiro, prato da mola	98....	VKDA 35503	1		
	Eixo traseiro, prato da mola	...98	VKDA 35503	1		
	Motor, alternador, diant.	70A	6203-2RSH/C3HT22VT200	1		
	Motor, alternador, diant.	70/ 120A	BB1-3065 C	1		
	Motor, alternador, tras.	70/ 120A	6003-2RS1/C3GJN	1		
	Motor, alternador, tras.	70A	6203-2RSH/C3HT22VT200	1		

GM - Continuação





















Aplicações diversas

Veículo	Aplicação	Observações	Designação SKF	Qt.	Rol.	
KIA	Besta (2.2, 2.7 e GS)	Câmbio, eixo intermediário, dir.	63/28	1		
		Câmbio, eixo primário, dir.	6306-ZNR	1		
		Câmbio, eixo secund., dir.	6304-Z	1		
		Câmbio, eixo secund., esq.	6205	1		
		Direção, pinhão cônico, diant.	30307 J2/Q	1		
		Direção, pinhão cônico, tras.	30306 J2/Q	1		
	Sportage (2.0 e 2.2)	Diferencial, coroa, lat. dir. e esq.		32008 X/Q	2	
		Diferencial, pinhão cônico, diant.		32207 J2/Q	1	
		Diferencial, pinhão cônico, tras.		32206 J2/Q	1	
LADA	Laika (1.6)	Câmbio, eixo intermediário, tras.	613441	1		
		Câmbio, eixo primário	615722	1		
		Câmbio, eixo secund., diant.	6306 NR	1		
		Câmbio, eixo secund., tras.	613441	1		
		Câmbio, eixo secund., tras.	4 marchas 6205	1		
		Cardan, suporte		62205-2RS1	1	
		Diferencial, coroa, lat. dir. e esq.		639114	2	
		Motor, alternador, diant.		6302-2RS1/C3	1	
		Motor, alternador, tras.		6201-2RSH/C3GJN	1	
LADA	Niva (1.6)	Caixa de transferência, eixo intermediário, tras.	6306 NR	1		
		Caixa de transferência, eixo primário, tras.	6306 NR	1		
		Caixa de transferência, eixo primário, diant.	615722	1		
		Caixa de transferência, eixo secund., diant.	6305	1		
		Caixa de transferência, eixo secund., interm.	6209	1		
		Caixa de transferência, eixo secund., interm.	6209 N	1		
		Caixa de transferência, eixo secund., tras.	6305	1		
		Câmbio, eixo intermediário, tras.	613441	1		
		Câmbio, eixo primário	615722	1		

Aplicações diversas

Veículo	Aplicação	Observações	Designação SKF	Qt.	Rol.	
LADA - Continuação	...Continuação Niva (1.6)	Câmbio, eixo secund., diant.	6306 NR	1		
		Câmbio, eixo secund., tras.	613441	1		
		Câmbio, eixo secund., tras.	4 marchas 6205	1		
		Diferencial, coroa, lat. dir. e esq.	639114	2		
		Eixo dianteiro, semi eixo dir. e esq.	6306 NR	2		
		Embreagem, apoio	62202-2RS1/C3	1		
		Motor, alternador, diant.	6302-2RS1/C3	1		
		Motor, alternador, tras.	6201-2RSH/C3GJN	1		
	Samara (1.3 e 1.5)		Câmbio, eixo primário, dir.	NJ 205 ECP/C3	1	
			Câmbio, eixo primário, esq.	BB1B 362711 A	1	
		Câmbio, engrenagem	1º velocidade K 32x37x27	1		
		Diferencial, coroa, lat. dir. e esq.	30207 J2/Q	2		
		Direção, coluna	61805	1		
		Eixo dianteiro, prato de mola	32008 X/Q	1		
		Embreagem, apoio	NJ 205 ECP/C3	1		
		Motor, alternador, diant.	6302-2RS1/C3	1		
		Motor, alternador, tras.	6201-2RSH/C3GJN	1		
MAZDA	626 (1.8 e 2.0 16V)	Eixo dianteiro, prato de mola	VKDA 88402	1	KIT	
MBB	180 D	Diferencial, coroa, lat. dir. e esq.	32010 X/Q	1		
		Eixo dianteiro, manga de eixo	HK 2526	1		
		Motor, alternador, diant.	Bosch 6303-2RSH/C3HT	1		
		Motor, alternador, tras.	Bosch 6201-2RSH/C3GJN	1		
	Classe A (1.6 e 1.9)	Eixo dianteiro, prato de mola	VKD 35005	1		
Sprinter	Diferencial, caixa satélite		LM 806649/610/Q	1		
	Diferencial, corpo pinhão, ext.		HM 803146/2/110/2/QCL7C	1		
MITSU-BISHI	Pajero I (2.5, 2.8, 3.0 e 3.5)	Diferencial, pinhão cônico, diant. e tras.	HM 89449/2/410/2/QCL7C	1		
PEUGEOT	106 (1.0, 1.4 e 1.6)	Eixo dianteiro, prato de mola	VKDA 35302	1		
	205 (1.3, 1.4 e 1.6)	Câmbio, eixo primário, tras.	6205	1		













Aplicações diversas

Veículo	Aplicação	Observações	Designação SKF	Qt.	Rol.	
PEUGEOT - Continuação	...Continuação 205 (1.3, 1.4 e 1.6)	Diferencial, coroa, lat. dir. e esq.	JL 69349 X/310/Q	2		
		Eixo dianteiro, prato de mola	VKDA 35305	1		
		Eixo dianteiro, transmissão	6006-RS1/C3GJN	1		
		Motor, alternador, diant.	Bosch Mitsubishi 6201-2RSH/C3GJN	1		
	206 (1.0 nacional, 1.4 e 1.6 import.)	Eixo dianteiro, prato de mola		VKD 35002	1	
	306 (1.6, 1.8 e 2.0)	Eixo dianteiro, transmissão		6006-2RS1/C3GJN	1	
		Eixo dianteiro, prato de mola		VKD 35002	1	
	405 (1.6, 1.8 e 2.0)	Eixo dianteiro, prato de mola	07/96...	VKDA 35305	1	
		Eixo traseiro, braço da suspensão	...06/92 exceto 4X4	VKDA 27006	1	KIT
	406 (2.0 8V/16V)	Eixo dianteiro, prato de mola		VKD 35007	1	
Boxer (2.5/2.8 Furgão)	Eixo dianteiro, suspensão		VKD 35017 T	1		
Partner (1.6 e 1.8 gasol.)	Eixo dianteiro, prato de mola	com DH	VKDA 35306	1		
	Eixo dianteiro, prato de mola	sem DH	VKDA 35307	1		
RENAULT	Clio (1.6 importado)	Eixo dianteiro, prato de mola	8V VKDA 35601	1		
	Kangoo (1.0 e 1.6)	Eixo dianteiro, prato de mola	VKDA 35607	1		
		Eixo traseiro, braço da suspensão	VKDA 27009	1	KIT	
	Laguna (2.0)	Eixo dianteiro, prato de mola	VKD 35001	1		
		Embreagem, apoio	6203-2RSH/C3HT22VT200	1		
	Mégane/Mégane Sedan (1.6 e 2.0 8V/16V)	Eixo dianteiro, prato da mola	VKDA 35615	1		
		Eixo traseiro, braço da suspensão	VKDA 27009	1	KIT	
	R 19 (1.6 e 1.8)	Eixo dianteiro, prato de mola	...96 VKDA 35615	1		
		Eixo traseiro, braço da suspensão	...95 VKDA 27009	1	KIT	
	R 21 (1.6, 2.0, 2.1D e 2.2)	Eixo dianteiro, prato de mola	VKD 35001	1		
Motor, alternador, diant.		exceto 2.1D 6203-2RSH/C3HT22VT200	1			
Motor, alternador, tras.		exceto 2.1D 6202-2RSH/C3GJN	1			
Scénic (1.6 16V e 2.0 8V/16V)	Eixo dianteiro, prato da mola	VKDA 35615	1			
Traffic (2.1, 2.2 e 2.5)	Câmbio, eixo secund., diant.	NU 2205 ECP	1			
	Diferencial, caixa satélite	6006-2RS1	1			

Aplicações diversas









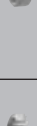

Veículo	Aplicação	Observações	Designação SKF	Qt.	Rol.
RENAULT - Continuação	...Continuação Traffic (2.1, 2.2 e 2.5)	Diferencial, coroa, lat. dir. e esq.	32009 X/Q	2	
		Eixo traseiro, semi eixo	6006-2RS1	1	
		Embreagem, apoio	6203-2RSH	1	
		Motor, alternador, diant.	Indiel e Argelite 6203-2RSH/C3HT22VT200	1	
		Motor, alternador, tras.	Indiel e Argelite 6202-2RSH/C3GJN	1	
TOYOTA	Bandeirante	Caixa de transf., eixo de entrada	...05/81 6306-2Z	1	
		Caixa de transf., eixo de tração, diant	05/81... 6306-2Z	1	
		Caixa de transf., eixo entalhado, diant. e tras.	05/81... 30307 J2/Q	2	
		Caixa de transf., eixo entalhado, diant. e tras.	...05/81 6307-Z	2	
		Caixa de transf., eixo intermediário, diant.	...05/81 6306-2Z	1	
		Câmbio, eixo primário, diant.	...05/81 6209 NR/C3	1	
		Câmbio, eixo primário, tras.	...05/81 6307-Z	1	
		Diferencial dianteiro, pinhão cônico, diant.	 31308 J2/QCL7C	1	
		Diferencial dianteiro, pinhão cônico, diant. e tras.	 31306 J2/Q	2	
		Diferencial traseiro, pinhão cônico, tras.	10/67... 31308 J2/QCL7C	1	
		Embreagem, apoio	 6202-2Z	1	
		Motor, alternador, diant.	Bosch 6200-2RS1/C3GJN	1	
		Motor, alternador, diant.	Bosch/Wapsa 6203-2RSH/C3HT22VT200	1	
		Motor, bomba d'água	 6206-2Z	1	
		Motor, bomba d'água, tras.	 6203-2Z/C3	1	
		Motor, bomba injetora, diant.	 6203	1	
		Motor, dínamo, diant. e tras.	Wapsa 6202-2RSH/C3GJN	1	
		Tomada de força, eixo do carretel, dir. e esq.	...05/81 6203-2Z	2	
		Tomada de força, eixo entalhado, dir.	...05/81 31308 J2/QCL7C	1	
		Tomada de força, eixo entalhado, esq.	...05/81 6205-2Z	1	
VW	Apollo	Câmbio, eixo secund., diant.	L 45449 F/410/Q	1	
		Câmbio, eixo secund., interm.	330757 C/Q	1	
		Diferencial, coroa, lat. dir. e esq.	LM 29749/710/Q	2	

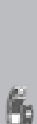
Aplicações diversas

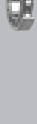
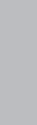
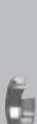
Veículo	Aplicação	Observações	Designação SKF	Qt.	Rol.
...Continuação Apollo	Eixo dianteiro, prato da mola		BD1B 1820200 A	1	
	Motor, alternador, diant.		6203-2RSH/C3HT22VT200	1	
	Motor, alternador, tras.		6201-2RSH/C3GJN	1	
Bora (2.0)	Eixo dianteiro, prato da mola		VKDA 35113	1	
Brasília (1500 e 1600), Fusca (1300, 1300L, 1500 e 1600), Variant I	Motor, alternador, diant.	Bosch	6203-2RSH/C3HT22VT200	1	
	Motor, alternador, tras.	Variant I Bosch	6201-2RSH/C3GJN	1	
	Motor, alternador, tras.	Bosch	6202-2RSH/C3GJN	1	
	Motor, dínamo, diant. e tras.		6202-2RSH/C3GJN	2	
Gol (refrig. a água), Parati	Diferencial, coroa, lat. dir e esq..	5 marchas	LM 300849/811/Q	2	
	Eixo dianteiro, prato da mola		BD1B 1820100 A	1	
Gol (refrig. a água), Parati (motor AT)	Motor, alternador, diant.	Bosch/Wapsa 35/45/55/65 A	6203-2RSH/C3HT22VT200	1	
	Motor, alternador, diant.	65/ 70/ 75/ 90 A (96...)	BB1-3065 C	1	
	Motor, alternador, tras.	65/ 70/ 75/90 1.0 Mi 16V	6003-2RS1/C3GJN	1	
	Motor, alternador, tras.	Bosch/Wapsa 35/ 45/ 55/ 65/ 95 A	6201-2RSH/C3GJN	1	
Gol (refrig. a água) e Parati (motor CHT)	Motor, alternador, diant.	Bosch/Wapsa 35/ 45/ 55/ 65 A	6203-2RSH/C3HT22VT200	1	
	Motor, alternador, tras.	Bosch/Wapsa 35/ 45/ 55/ 65/ 95 A	6201-2RSH/C3GJN	1	
Gol (refrig. a água), Parati (AP 1.6, 1.8, 2.0 e Mi)	Motor, alternador, diant.	Bosch/Wapsa 35/ 45/ 55/ 65 A	6203-2RSH/C3HT22VT200	1	
	Motor, alternador, diant.	65/ 70/ 75/ 90 A (96...)	BB1-3065 C	1	
	Motor, alternador, tras.	65/ 70/ 75/ 90 1.6 Mi	6003-2RS1/C3GJN	1	
	Motor, alternador, tras.	Bosch/Wapsa 35/ 45/ 55/ 65/ 95 A	6201-2RSH/C3GJN	1	
	Motor, alternador, tras.	70/ 90 A 16V	6203-2RSH/C3HT22VT200	1	
Gol (refrig. a ar 1.3 e 1.6)	Diferencial, coroa, lat. dir. e esq.	4 marchas	LM 300849/811/Q	2	
	Eixo dianteiro, prato da mola		BD1B 1820100 A	1	
	Motor, alternador, diant.	Bosch 35A-BP	6203-2RSH/C3HT22VT200	1	
	Motor, alternador, tras.	Bosch 35A-BP	6202-2RSH/C3GJN	1	
	Motor, dínamo	25A-2BP	6202-2RSH/C3GJN	1	
	Motor, dínamo, diant.	Bosch 25A-20U	6202-2RSH/C3GJN	1	
	Motor, dínamo, tras.	Bosch 25A-20U	6201-2RSH/C3GJN	1	

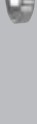
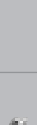











VW - Continuação

Aplicações diversas

Veículo	Aplicação	Observações	Designação SKF	Qt.	Rol.
Golf A4 (importado 08/98...07/99 e nacional 08/99...)	Câmbio, eixo primário, diant.	5 marchas	BT1B 328236 A/QCL7VC027	1	
	Câmbio, eixo ré, diant.	1.8 e 2.0 4 marchas automático	LM 29749/710/Q	1	
	Diferencial, coroa, lat. dir. e esq.	4 e 5 marchas automático	LM 300849/811/Q	2	
Golf importado (02/94....07/98)	Câmbio, eixo ré, diant.	1.8 e 2.0 4 marchas automático	LM 29749/710/Q	1	
	Câmbio, eixo secund., diant.	1.8/ 2.0 e 2.8 5 marchas	L 45449 F/410/Q	1	
Kombi (1500 e 1600)	Caixa de redução de veloc., ponta de eixo, int.	02/78...	6306/C3	1	
	Caixa de redução de veloc., semi eixo ext.	02/78...	6305/C3	1	
	Caixa de redução de veloc., semi eixo int.	02/78...	6306/C3	1	
	Diferencial, coroa, lat. dir. e esq.	10/75...	LM 300849/811/Q	2	
	Eixo traseiro, ponta de eixo, int.	02/78...	6207/C3	1	
	Motor, alternador, diant.	Bosch 35A-BP	6203-2RSH/C3HT22VT200	1	
	Motor, alternador, tras.	Bosch 35A-BP	6202-2RSH/C3GJN	1	
	Motor, dínamo	Bosch / Wapsa 25A-BP	6202-2RSH/C3GJN	1	
	Motor, dínamo, diant.	Bosch 25A-20U	6202-2RSH/C3GJN	1	
	Motor, dínamo, tras.	Bosch 25A-20U	6201-2RSH/C3GJN	1	
Logus (1.6 e 1.8)	Câmbio, eixo primário, esq.	5 marchas	BT1B 328236 A/QCL7VC027	1	
	Câmbio, eixo secund., dir.	5 marchas	L 45449 F/410/Q	1	
	Câmbio, eixo secund., esq.	5 marchas	LM 29749/710/Q	1	
	Diferencial, coroa, lat. dir. e esq.	5 marchas	BT1B 328612 C/QCL7C	2	
	Motor, alternador, diant.		6303-2RSH/C3HT	1	
	Motor, alternador, tras.		6201-2RSH/C3GJN	1	
Passat (1.5, 1.6 e 1.8)	Câmbio, eixo primário, tras.	...07/84 4 marchas	361895 B	1	
	Diferencial, coroa, lat. dir. e esq.	...07/84 4 marchas, 5 marchas	LM 300849/811/Q	2	
	Direção, pinhão cônico, tras.		6001/C3	1	
	Eixo dianteiro, prato da mola		BD1B 1820100 A	1	
	Motor, alternador, diant.	Bosch / Wapsa 35/ 45/ 55/ 65 A	6203-2RSH/C3HT22VT200	1	
	Motor, alternador, diant.	65 / 70/ 75/ 90 A (96...)	BB1-3065 C	1	
	Motor, alternador, tras.	65/ 70/ 75/ 90 1.6 Mi	6003-2RS1/C3GJN	1	

VW - Continuação

Aplicações diversas

Veículo	Aplicação	Observações	Designação SKF	Qt.	Rol.		
VW - Continuação	...Continuação Passat (1.5, 1.6 e 1.8)	Motor, alternador, tras.	Bosch / Wapsa 35/ 45/ 55/ 65/ 95 A	6201-2RSH/C3GJN	1		
	Pointer (1.8 e 2.0)	Câmbio, eixo primário, esq.	5 marchas	BT1B 328236 A/QCL7VC027	1		
		Câmbio, eixo secund., dir.	5 marchas	L 45449 F/410/Q	1		
		Câmbio, eixo secund., esq.	5 marchas	LM 29749/710/Q	1		
		Diferencial, coroa, lat. dir. e esq.	5 marchas	BT1B 328612 C/QCL7C	2		
		Motor, alternador, diant.		6303-2RSH/C3HT	1		
		Motor, alternador, tras.		6201-2RSH/C3GJN	1		
	Polo e Polo Classic	Câmbio MQ, eixo primário, tras.		BT1B 328236 A/QCL7VC027	1		
		Câmbio MQ, eixo secund., diant.		L 45449 F/410/Q	1		
		Câmbio MQ, eixo secund., tras.		LM 29749/710/Q	1		
		Diferencial, coroa, lat. dir. e esq.	Somente Polo	LM 300849/811/Q	2		
		Eixo dianteiro, prato da mola	Polo 10/99...	VKDA 35115	2		
		Eixo dianteiro, prato de mola	Polo Classic...09/99	VKDA 35110	2		
	Santana/ Santana Quantum (1.6, 1.8 e 2.0)	Diferencial (caixa autom.), coroa, lat. dir. e esq.		LM 29749/710/Q	2		
		Diferencial (caixa autom.), pinhão cônico, diant. e tras.		M 86649/2/610/2/QVQ506	2		
		Diferencial, coroa, lat. dir. e esq.	5 marchas	LM 300849/811/Q	2		
		Direção, chave de seta		309544 DB	1		
		Eixo dianteiro, prato da mola		BD1B 1820100 A	1		
		Motor, alternador, diant.	Bosch/ Wapsa 35/ 45/ 55/ 65 A	6203-2RSH/C3HT22VT200	1		
		Motor, alternador, diant.	AP 2.0i com ar condicion.	6303-2RSH/C3HT	1		
		Motor, alternador, diant.	65/70/75/90 (96...)	BB1-3065C	1		
		Motor, alternador, tras.	70/90 A	6203-2RSH/C3HT22VT200	1		
		Motor, alternador, tras.	65/ 70/ 75/ 90 1.8 Mi	6003-2RS1/C3GJN	1		
Motor, alternador, tras.		Bosch / Wapsa 35/ 45/ 55/ 65/ 95 A	6201-2RSH/C3GJN	1			
Motor, alternador, tras.							
Saveiro e Voyage	Diferencial, coroa, lat. dir. e esq.	5 marchas	LM 300849/811/Q	2			
	Eixo dianteiro, prato da mola		BD1B 1820100 A	1			
	Motor, alternador, diant.	Bosch / Wapsa 35/ 45/ 55/ 65 A	6203-2RSH/C3HT22VT200	1			
	Motor, alternador, diant.	65/ 70 / 75 / 90 A (96...)	BB1-3065 C	1			

Aplicações diversas

Veículo	Aplicação	Observações	Designação SKF	Qt.	Rol.	
VW - Continuação	...Continuação Saveiro e Voyage	Motor, alternador, tras.	65/ 70/ 75/ 90 1.6 Mi	6003-2RS1/C3GJN	1	
		Motor, alternador, tras.	Bosch / Wapsa 35/ 45/ 55/ 65/ 95 A	6201-2RSH/C3GJN	1	
	Variant I e II	Motor, alternador, diant.	Variant I Bosch	6203-2RSH/C3HT22VT200	1	
		Motor, alternador, tras.	Variant I Bosch	6201-2RSH/C3GJN	1	
		Eixo dianteiro, prato da mola		BD1B 1820100 A	1	
		Motor, alternador, diant.	Bosch 35A-BP	6203-2RSH/C3HT22VT200	1	
		Motor, alternador, tras.	Bosch 35A-BP	6202-2RSH/C3GJN	1	
		Motor, dínamo	25A-BP	6202-2RSH/C3GJN	1	
		Motor, dínamo, diant.	Bosch 25A-20U	6202-2RSH/C3GJN	1	
Motor, dínamo, tras.	Bosch 25A-20U	6201-2RSH/C3GJN	1			

Tipos de rolamentos

 Rótula radial	 Rolamento para cubo de roda, primeira geração	 Rolamento de agulhas	 Rolamento de duas carreiras de esferas	 Rolamento para cubo de roda, terceira geração
 Rolamento de rolos cilíndricos	 Rolamento de rolos cônicos	 Rolamento rígido de esferas	 Rolamento para cubo de roda, segunda geração	 Rolamento de agulhas
 Rolamento axial de agulhas	 Rolamento de quatro pontos de contato	 Rolamento para cubo de roda, primeira geração	 Gaiola de agulhas	
 Rolamento axial de esferas	 Rolamento de suspensão	 Rolamento de embreagem	 Rolamento autocompensador de rolos	

Graxa automotiva



Graxa SKF GS - 265 A Automotiva

Especificações técnicas

Agente engrossante (sabão)	Lítio
Percentagem de sabão	8%
Óleo base	mineral
Viscosidade cinemática do óleo-básico a 40°C, cSt	208,6
Consistência (NLGI)	2
Ponto de gota, °C	188
Coloração	âmbar
Textura	manteigosa
Faixa de temperatura de operação, °C	-10 a 110

Características

A graxa GS - 265 A foi criada especialmente para a lubrificação de cubos de rodas de automóveis, caminhões e ônibus.

A alta viscosidade do seu óleo-básico garante a formação de uma película lubrificante de elevada resistência, que protege os rolamentos do desgaste prematuro e inibe a corrosão.

O sabão de lítio empregado em sua fórmula proporciona excelente estabilidade mecânica e longa duração em serviço.

Aplicações

- Cubos de rodas de automóveis, caminhões e ônibus;
- Articulações de suspensão dianteira;
- Rolamentos pequenos e grandes com carga normal e rotações moderadas, não superiores a metade do limite do catálogo.

Embalagem

- Disponível em embalagens de 1Kg e 500g.
- Balde de 20Kg.
- Bisnaga com 50g.



Produtos Automotivos SKF

...ou você pensa que temos somente os melhores rolamentos?



A SKF disponibiliza ao mercado de reposição uma ampla linha de produtos que você já conhece e confia.

Visite seu distribuidor SKF mais próximo e solicite os já tradicionais Rolamentos Automotivos, Cruzetas, Atuadores Hidráulicos e Mancais de Embreagens, Bombas D'água, Polias e Tensionadores de Correas, Kits de Rolamentos de Rodas, Componentes de Direção e Suspensão, além do mais recente lançamento: - Kits de Reparo para Juntas Homocinéticas - que já encontram-se disponíveis para sua maior tranquilidade e segurança.

SKF. Só quem é líder mundial pode oferecer ao mercado de reposição, uma linha de produtos tão completa.